

## CONTENTS

<b>Chapter 1</b>	<b>Introduction</b>	<b>1</b>
1.1	Research questions	1
1.2	The South African context	1
1.3	Rationale	6
1.4	The role of problem solving in physics	8
1.5	The structured problem solving strategy	10
1.6	Outline of the study	12
1.7	Limitations	13
1.8	Organisation of the thesis	14
<b>Chapter 2</b>	<b>Literature survey</b>	<b>15</b>
2.1	Problem solving in physics by individuals	15
2.2	Conceptual understanding of physics	18
2.3	Instructional strategies	21
2.3.1	Structured problem solving	21
2.3.2	Explicit problem solving	22
2.3.3	Structured problem solving and cooperative groups	23
2.3.4	The classroom based study of Huffman	24
2.3.5	Modelling Instruction	25
2.3.6	Overview, Case Study Physics	26
2.3.7	Qualitative strategy writing	26
2.3.8	Summary	27
2.4	Implications for science education in South Africa	28

<b>Chapter 3</b>	<b>Theoretical framework</b>	<b>30</b>
3.1	Greeno’s model for scientific problem solving	30
3.2	The problem solving strategy interpreted in terms of Greeno’s model	34
<b>Chapter 4</b>	<b>Research methodology</b>	<b>37</b>
4.1	Design of the study	37
4.2	Sample	39
4.3	Collection of data	41
4.4	Data analysis	43
	4.4.1 Quantitative	43
	4.4.2 Qualitative	43
4.5	Instruments	44
	4.5.1 Reliability	44
	4.5.2 Validity	44
4.6	Validity of the design	46
	4.6.1 Internal validity	46
	4.6.2 External validity	46
<b>Chapter 5</b>	<b>Results: quantitative</b>	<b>49</b>
5.1	Sample profile	49
5.2	Test scores	51
5.3	Pass rate	55
5.4	Quantitative evidence of reliability and validity	57
5.5	Interactions with the treatment	59
5.6	Quantitative description of conceptualizing	61
5.7	Chapter summary	65

<b>Chapter 6</b>	<b>Results: qualitative</b>	<b>67</b>
6.1	Solutions maps	67
6.1.1	Work and energy	68
6.1.2	Kinematics	76
6.1.3	Electrostatics	82
6.1.4	Solutions maps interpreted in terms of a conceptual approach	86
6.1.5	Section summary	89
6.2	Case studies: video session	90
6.2.1	The accelerating charge	92
6.2.2	The pendulum collision problem	96
6.2.3	Section summary	104
6.3	Questionnaires	105
6.3.1	Treatment group's questionnaire	106
6.3.2	Video group's questionnaire	107
6.3.3	Teachers' questionnaire	108
6.3.4	Section summary	109
6.4	Chapter summary	110
<b>Chapter 7</b>	<b>Synthesis</b>	<b>112</b>
7.1	Interpretation of results	112
7.1.1	Claims	112
7.1.2	The co-development of conceptual understanding and problem solving skills	116
7.1.3	The development of a conceptual approach to problem solving	117
7.2	Significance of the study	118
7.2.1	Social knowledge construction	118
7.2.2	Second language development	119
7.3	Recommendations	120

<b>REFERENCES</b>	<b>123</b>
<b>APPENDIXES</b>	<b>129</b>
1. Pre-test	130
2. February test	130
3. March test	131
4. May test	132
5. June examination	133
6. Treatment group's questionnaire	139
7. Video group's questionnaire	140
8. Teacher's questionnaire	141
9. Examples of conceptual and algebraic solutions	145

**LIST OF TABLES**

Table 3.1	Knowledge of electric circuits in terms of Greeno’s model	33
Table 3.2	Activities required by using the problem-solving strategy interpreted as translations between Greeno’s four knowledge domains	35
Table 4.1	School information	40
Table 5.1	Number of students taking tests throughout the study	50
Table 5.2	Comparison of the average test and examination scores for the treatment and control groups.	52
Table 5.3	Comparison of average scores obtained by the two groups for separate questions in the June examination.	54
Table 5.4.	Pass rate in the pre-test and June examination	55
Table 5.5.	Pre-test performance of the 48 candidates who passed the problem section of the June examination	56
Table 5.6	Correlation coefficients for scores for the tests and the June exam as well as for the June and September examination	58
Table 5.7	Average scores by gender in the problem section of the June examination	59
Table 5.8	Two-factor ANOVA table corresponding to the insignificant gender x treatment interaction	60
Table 5.9	Two-factor ANOVA results showing no interactions with the treatment	61
Table 5.10	Contingency table showing the differences in the treatment and control group’s problem solving approaches	63
Table 5.11	Contingency table showing problem solving performance in relation to problem-solving approach for the entire sample	63
Table 5.12	Breakdown of student performance in the June exam in terms of approach to problem solving, showing the treatment group, control group as well as the difference between the groups	64
Table 6.1	Comparison of conceptual fractions for the treatment and control groups for selected examples from the June examination	87

**LIST OF FIGURES**

Figure 3.1	Greeno’s four domains of knowledge for scientific problem solving, shown with connections between as well as within domains	32
Figure 3.2	Greeno’s explanation of insulated algebraic problem solving	34
Figure 5.1	Pretest profile of all the candidates who passed the problem section of the June examination	56
Figure 5.2	Scatter plot to relate test results and the June exam scores	57
Figure 5.3	Scatter plot to relate September and the June exam scores	58
Figure 5.4	Illustration of the insignificant interaction between the treatment and gender	60
Figure 6.1	Breakdown of students’ solutions to the energy conservation problem	71
Figure 6.2	Breakdown of students’ solutions to the work-energy problem	74
Figure 6.3	Breakdown of students’ solutions to the kinematics problem	80
Figure 6.4	Breakdown of students’ solutions to the electrostatics problem	84
Figure 6.5a	Comparison of the C-index for the correct solution and an inappropriate formula-based solution to the energy conservation problem	88
Figure 6.5b	Comparison of the C-index for the correct solution and an inappropriate formula-based solution to the electrostatics problem	88
Figure 6.6	Ntombi’s solution to the problem of the accelerating charge in the video session	94
Figure 6.7a	First part of Sam’s solution to the problem of the pendulum-collision in the video session	98
Figure 6.7b	Second part of Sam’s solution to the problem of the pendulum-collision in the video session	100
Figure 6.8	David’s solution to the problem of the pendulum-collision in the video session	103

## CHAPTER 1

### INTRODUCTION

#### 1.1 RESEARCH QUESTIONS

The purpose of this study was to explore the possibility of structured problem solving in physics being utilized in disadvantaged South African schools in order to improve learners' performance and conceptual understanding. The type of problem refers to the typical textbook and examination problems encountered in senior high school physics in South Africa, covering the topics of mechanics and electricity, without the use of calculus.

The experiment was conducted in South African high schools in disadvantaged black communities. Most of the learners were at a disadvantage due to poor previous schooling, instruction in a second language, and a shortage of qualified teachers, large classes and poor facilities. A structured problem-solving strategy was implemented by means of a cascade from researcher to teachers, and teachers to students. Two specific questions were investigated:

1. What was the effect of a structured problem-solving strategy on physics test and examination scores in disadvantaged South African high schools?
2. What was the effect of a structured problem-solving strategy on conceptual understanding of physics in disadvantaged South African high schools?

#### 1.2 THE SOUTH AFRICAN CONTEXT

What is meant by “disadvantaged” South African schools? From 1948 to 1994, South Africa was governed by a white minority government under the apartheid system. The black population had no representation in the central government. Before the transition to democracy in 1994, education was divided along racial lines. For blacks, education did not follow a European model, as to prevent blacks aspiring to positions, which were reserved for whites (Hartshorne, 1992). The policy of inferior education for blacks was reflected in funding. In the early nineteen

seventies, funding per child was at a ratio of 1:15 for black and white children. Although this ratio improved to 1:5 in 1990, inequality prevailed. Regarding teacher education, black teachers were trained in isolated colleges, where science and mathematics had a low priority. Consequently, a lack of understanding of the relevance of science and new developments in didactics was prevalent (Arnott, Kubeka, Rice, & Hall, 1997). Furthermore, teachers were poorly qualified. In 1988, only 13.5% of teachers in secondary schools had degrees, and almost 40% had no qualifications to teach in secondary schools. Many teachers depended on the security of a single textbook and notes that were to be memorized (Hartshorne, 1992). Pupils were given little time for questions, discussions, active participation or group work. It was common for learners to pass physical science and enter tertiary institutions without ever having touched any laboratory equipment. The result of this educational system was a perpetuation of racial inequality.

The 1976 school riots were sparked by educational issues and fuelled by the black population's political, social and economic frustrations. Tragically, the disruption of black education had devastating effects on the culture of learning in black schools (Hartshorne, 1992). The high failure rate of 47.8% in the 1980 final examinations increased to 58.2% in 1989. In sharp contrast, the failure rate in the white schools was a mere 4%.

After the 1994 elections, all forms of discrimination were removed by law, but the effects of apartheid education would remain for many years to come. Johnson, Monk and Hodges (2000) argued that teaching practices, school ethos, staff qualifications, administrative expertise and parental support could not be changed overnight through ballot papers. Poor academic standards and lack of facilities are a reality in most of the rural schools and "township" schools on the outskirts of cities. In 1995, as many as 60% of science teachers had no training in science (Arnott, Kubeka, Rice & Hall, 1997). Many of those who were qualified were trained during the apartheid period in the black education colleges where poor academic standards were the norm. It is not surprising that so little effect is visible after ten years of democracy as the transformation of education is a slow process. An individual teacher can continue teaching in one way for almost 40 years, influencing learners who become part of the next generation of teachers. Ten years into democracy, the black schools created by the apartheid government are still at a disadvantage.



Since the mid nineteen seventies, nongovernmental organizations (NGO's) became actively involved in the development of science education in South Africa's disadvantaged schools (Rogan & Gray, 1999). By the early nineteen nineties, over 100 NGO's had been involved in independent projects – a sure indicator of the urgent need for interventions (Kahn, 1994). The pioneer of these organizations, the Science Education Program (SEP) started out to develop practical work in junior secondary schools. Within a few years, SEP evolved into an agent for much needed in-service teacher development (Rogan & Macdonald, 1985). Teachers started setting a greater variety of questions, although these were still on a low cognitive level (Macdonald & Rogan, 1988). Pupils' attitudes and performances improved somewhat, but they were still reluctant to ask questions of their teachers. The persistent expository style of teachers and pupils' passivity was not only a result of teacher insecurity, but also of cultural pressures (Macdonald & Rogan, 1990). In the African culture, the accepted sources of knowledge are rhetoric and authority, while empirical evidence is not valued. Reform of science education in South Africa and other third world countries, therefore, needs to address epistemological issues (Monk & Johnson, 1995; Johnson, Monk & Hodges, 2000).

In the nineteen eighties, universities started joining the effort of making science accessible to disadvantaged learners. The University of the Witwatersrand undertook an evaluation of their bridging course in order to compare the success rates of learners from different racial groups. It was found that black learners started poorly but improved throughout the year. In the final examination, black learners outperformed whites that had similar school performance ratings (Stanton, 1987). This was a clear indication that interventions on a tertiary level can be successful in overcoming disadvantaged school backgrounds in South Africa. Currently, most South African universities offer special programmes for promising learners who do not meet the entrance requirements for the normal, three-year B.Sc. degree (Pinto, 2001). These programmes usually involve one additional year of study. Some offer a non-credit-bearing year followed by the normal three years, while others offer two credit-bearing years followed by the mainstream second and third years of the B.Sc. degree. The programmes have various names, e.g. foundation year, bridging course, entry programme, four-year B.Sc. and College of Science. Apart from scientific content and skills to bridge the gap between poor schooling and university

requirements, English language development and life skills are usually incorporated (Grayson, 1996; Pinto, 2001; Rutherford, 1997). The programmes are reported to be reasonably successful, for example, an average of about 40% of the four-year B.Sc. learners at the University of Natal have completed their degrees (Parkinson, 2000). Although these special programmes should not be regarded as a permanent solution or a substitute for adequate instruction in schools, they can be a valuable interim arrangement until the situation at schools is eventually normalized.

Some unfounded optimism has been created by an improvement in the overall grade 12 pass rate over the last few years, from 57.9% in 2000 to 73.3% in 2003 (Department of Education, 2003). However, this improvement was a result of a decreased number of candidates entering the examinations, rather than an increase in the number of passes. Science and mathematics are regarded as problematic subjects. Of all the learners who wrote the national physical science examination at the end of 2003, only 26.4% passed the higher grade (Department of Education, 2003). African representation is particularly poor. Nationwide, only 7 708 African learners passed the higher grade physical science examination in 2002 (Kahn, 2004). This represented less than 20% of all candidates who passed physical science on the higher grade in 2002. These figures predict a continued shortage of scientists, engineers and science teachers from South Africa's disadvantaged communities.

The results of the Third International Science and Mathematics Study (TIMSS) placed South Africa significantly below all other participating countries, 38 in total, including developing countries like Morocco, Chile, Tunisia, Indonesia and the Philippines (Howie, 2001). The poor performance of South African pupils was attributed to a variety of factors including teachers' inadequate subject knowledge, second language instruction, shortage of instructional materials, poor management of classroom activities, lack of professional leadership, difficulties in completing examination-driven syllabi, heavy teaching loads, overcrowded classrooms, poor communication between policymakers and teachers and lack of professional support.

Instruction in a second language is a major obstacle in science teaching in black schools (Arnott, Kubeka, Rice, & Hall, 1997). The home languages of most teachers and learners are any of the nine indigenous languages of South Africa. In Botswana, Prophet (1990) observed that there

seemed to be much confusion about the use of words, especially when attempting to formulate own ideas, observations and concepts. In the former South African black teacher training colleges, lecturers observed that English as a second language often caused problems with understanding and communication, but no efforts were made to bridge the gap between language and cognitive development (Arnott, Kubeka, Rice, & Hall, 1997).

Together with the TIMMS study, a secondary investigation into South African pupils' proficiency in English was undertaken (Howie, 2003). The results indicated that pupils' proficiency in English was a strong predictor of performance in mathematics, while home language and class size were not important. As mathematics and science achievements yielded similar results in the TIMSS study, it was expected that the predictors of achievement in mathematics would also be applicable to achievement in science. It seems that science education in South Africa is severely impeded by poor understanding of the English language.

After the landmark elections of 1994, South Africa became a non-racial democracy. The newly elected government prioritized educational reform. The racially based education departments of the apartheid years were transformed into nine non-racial provincial education departments (Government Gazette, 1995). An ambitious new national curriculum, known as Curriculum 2005 (Department of Education, 1997), was adopted with the vision of creating educational equality for all learners and preparing them for participating in a democratic society. Curriculum 2005 was founded on outcomes-based education (OBE). This was a drastic change from the previous examination-driven syllabus. Curriculum 2005 was implemented in all schools in a given grade level in a yearly progression up to grade 9, to be completely implemented by 2005. From grade 10 onwards, the traditional examination-driven curriculum would remain in place until 2006.

Implementation of the new curriculum proved to be difficult. The “top-down” approach strongly resembled the imposition of the apartheid curricula (Christie, 1999). Teachers were given in-service training in sometimes only one session. It was then expected of them to be able to develop their own learning programmes as envisioned by the new curriculum. This expectation did not materialize as most teachers lacked subject knowledge while suitable learner support materials were not available. Consequently, teachers found it difficult to change their teaching

practices (Stoffels, 2004). All schools were expected to implement the new curriculum, regardless of the state of existing facilities, teacher factors and school ethos. Christie (1999: 282) observed that the new policies would not benefit under-resourced schools; it would act as “extra burdens rather than opportunities for improvement”. Jansen (1999) warned that OBE would in fact undermine the already fragile learning environment in schools and classrooms, rather than spawn motivation. Much work on issues around implementation would be required to provide the next generation with a better education (Rogan & Grayson, 2003). Tragically, the present generation of black high school learners are, therefore, disadvantaged not only by the persisting mediocrity created by the apartheid school system, but also by the growing pains of the new education system.

### **1.3 RATIONALE**

*At this stage I wish to document a personal impression. In the mid nineteen nineties, the new Gauteng Department of Education started to organize multiracial teacher meetings that promoted professional development and teacher interaction across the racial divide. I attended the first of such meetings for physical science teachers in the region where I was a teacher. It was a big event with a huge turnout. The air was filled with anticipation as it was an opportunity to meet colleagues who were previously invisible, to share knowledge and experience - the start of a better future for all our learners. The agenda consisted of administrative issues and questions (i.e. problems) that were poorly answered in the previous year's final grade 12 examination. During the discussion of the administrative issues, teachers participated enthusiastically. Then came the physics problems. The presenter started a particular problem by stating: “The formula is...” while displaying a very long algebraic equation. The equation involved terms of work, kinetic and potential energy at lower and higher positions. No mention was made of the very simple work-energy principle hidden beneath the proliferation of terms in the equation. The presenter then showed numerical substitutions into the long equation, some algebra and a numerical answer. Just like that, without any kind of explanation or mention of where the learners went wrong in the examination. There were no questions, discussion or remarks from the audience. Instead, most of the teachers frantically copied the formula, running*

*the risk of missing some detail of the long, meaningless equation. It was one great opportunity missed - an anticlimax.*

*Was this event a reflection of a typical South African classroom situation? Was physics perceived and practised as formulae and algebra? Did learners act like a passive audience, copying from the chalkboard, without participation in the construction of knowledge and understanding of the principles of physics? In retrospect, I suspect that this study was conceived during that afternoon: Was it possible to utilize problem solving as a vehicle to improve the way physics was taught and learnt in disadvantaged South African schools?*

The vision was to empower disadvantaged learners to become active learners of physics by employing a structured problem-solving strategy. It would be a small intervention, targeting behaviour rather than content knowledge and resources. The strategy would develop actions and habits that require learners (and teachers) to make sense of physics instead of simply doing mathematics. A cascading model would be employed, where the researcher would train teachers while the teachers and learners would employ the strategy whenever solving problems. Teachers and learners could thus become actively involved in the processes of problem solving and knowledge construction. This could be an inexpensive but efficient way of improving disadvantaged physics learners' performance as well as conceptual understanding, thus opening doors to tertiary studies and scientific careers.

Problem solving in physics has been widely researched (Maloney, 1994; McDermott & Redish, 1999). Successful problem-solving practices range from using different representations, group work, debating and strategy writing. Various projects were reported in the literature where strategies for problem solving have been implemented to develop learners' problem-solving skills (McDermott & Redish, 1999). Most of these projects were undertaken at colleges and universities in the US, with the focus on introductory physics courses. The present study was conducted in disadvantaged high schools in a developing country. The successful practices documented in the literature were integrated and adapted to fit local conditions. No similar investigations have been reported in the literature.

#### 1.4 THE ROLE OF PROBLEM SOLVING IN PHYSICS

Physics instructors generally accept problem solving as *the* way to learn physics (Maloney, 1994). Hobden (1999) identified the following reasons for the central role that problem solving plays in the instruction of physics:

- the belief that problem solving is the only way to learn physics
- the belief that learning problem solving would benefit future study
- the belief that problem solving leads to the understanding of physics
- the belief that problem solving is the best way to demonstrate understanding for the purpose of evaluation
- the belief that problem solving is the best way to prepare for examinations
- the belief that general problem-solving skills are developed through problem solving in physics

The practical consequence of these beliefs is that problem solving dominates physics classroom activities, homework and examinations; at school level and in first year university physics courses, often at the expense of understanding physics concepts (Hobden, 1999). In the current study the role of problem solving will not be questioned. Instead problem solving will be utilised to enhance performance and conceptual understanding of physics in a disadvantaged school environment.

Difficulties with science teaching/learning are not unique to the developing world. In developed countries, academics are concerned with poor conceptual understanding of physics amongst university learners, despite satisfactory achievements in traditional examinations (Hewitt, 1983; McDermott, 1991; Redish, 1994; Reif, 1995; Van Heuvelen, 1991a). McDermott (1991) indicated that successful quantitative problem solving was no guarantee of conceptual understanding. She refers to typical introductory physics courses as passive learning experiences for many learners, with an emphasis on quantitative problem solving. Questions to stimulate the development of concepts and scientific reasoning are seldom posed. Redish (1994) referred to a “dead leaves model” where learners treat physics equations as if they were written on a collection of fallen leaves. They flip through their collection of dead leaves until they find the

right equation. Redish (1994) argued that learners should be given opportunities to explain their thoughts in words and that examination credits should be given for qualitative reasoning.

Conceptual understanding of problems is seldom evaluated in examinations; little attention is given to qualitative aspects of solutions. Although teachers spend much time on explaining the relevant physics before starting mathematical solutions in classroom examples, this effort is seldom reflected in *writing*. Mark allocation for examination problems does not reward written explanations, thus forming a vicious cycle. Not surprisingly, learners tend to skip explanatory sections in their textbooks and concentrate on mathematical solutions. Learners' written solutions tend to start with formulae and continue purely mathematically with no effort to explain the physics hiding behind the math. Over the past twenty years, research has focused on conceptual understanding, but classroom practice generally still focuses on quantitative aspects. Problems are stated in natural language, while physics principles are often reduced to their mathematical form and taught as formulae. Learners have to bridge the gap between the language of the stated problem and the formula. Ultimately, a problem has to be solved mathematically, creating the possibility for learners to succeed mathematically, without bridging the gap between a physics principle and the equation representing it.

What is the origin of the emphasis on algebraic problem solving instead of conceptual understanding? In South Africa, school physics problems in grades 8 and 9 usually involve simple relations of three physical quantities, for example density = mass/volume, resistance = potential difference/current and pressure = force/area. In symbolic form, these relations become formulae. Learners soon learn to focus on formulae, check symbols, substitute numbers and calculate answers. The meanings of the formulae can easily be overlooked – by teachers and by learners. Many learners, who find the problems difficult, can successfully be taught how to do the sums by matching information to symbols in formulae. The possibility that a student may experience difficulties conceptualizing, can go unnoticed and unattended. It may very well be easier to calculate “R”, rather than to attach meaning to the term resistance or to Ohm's law. By the time learners reach grades 11 and 12, they have learnt that formula-based problem solving is successful; the concepts and principles of physics can be bypassed: physics becomes algebra.

In grades 11 and 12, physics problems become more difficult. There are many more concepts and relationships to deal with. Furthermore, the concepts are more abstract and the relationships more complex than before. Some problems require using more than one relationship, where learners have to use unspecified linking variables. Some symbols represent more than one physical concept, for example, the symbol “E” is used for energy, electric field strength and for EMF. In addition, the many principles and relationships studied during the course add to confusion. For example, learners may be able to solve a pendulum problem while studying the chapter on energy, but when various topics are covered in an examination, they may be unable to select the appropriate principle – probably because they never really understood the relationship between the principle and the problem. The trusted algebraic approach, based on symbol matching, no longer guarantees success when physics becomes more complex. Instead, understanding physics concepts and their relationships to concrete situations become essential.

## **1.5 THE STRUCTURED PROBLEM-SOLVING STRATEGY**

The structured problem-solving strategy employed in this study envisaged that learners could develop understanding of physics concepts while learning the skill to solve problems. Qualitative aspects of problems were emphasized; algebra was part of a solution, not the entire solution. It was envisaged that learners could develop understanding of the meaning of numbers substituted and calculated. The strategy was taught explicitly to learners, and used by the teachers and learners, verbally and in writing, in classroom discussions and explanations, in group work and when learners worked individually on problems. The seven steps of the strategy are outlined below:

### **1. Diagram(s)**

Draw a simple diagram to represent the system, showing only relevant objects. Draw more diagrams when the problem involves more than one event.

### **2. Information**

Write down the information *on the diagram*, using standard scientific symbols.

When one variable occurs repeatedly, use subscripts, e.g.  $F_1$  and  $F_2$  or  $F_{\text{left}}$  and  $F_{\text{right}}$ .

### **3. Unknown**



Identify the unknown variable (the required answer).

#### **4. Analysis**

Analyse the problem in terms of known physics principles; the analysis should include *written* explanations, and when in class, *discussion* should precede writing.

Explain *in your own words* which principle applies to the situation and why it would solve the current problem.

For problems involving more than one event/object, identify appropriate physics principles describing each.

Identify variables that link different principles applicable to different parts of the problem.

#### **5. Relationships(s)**

Write down the relevant principle(s) identified in the analysis in symbolic form. (This is the formula where learners typically attempt to start a solution.)

#### **6. Substitution and Solution**

Convert the given quantities to appropriate units.

Substitute numbers into the equations, keeping the unknown quantity in symbolic form.

Solve algebraically for the unknown.

Linking variables (if any) should be calculated first.

Learners are advised to substitute numeric values before attempting to solve equations.

#### **7. Interpretation**

Explain the meaning of the numerical answer in words.

Add the appropriate unit, interpret the meaning of a negative sign and give the direction in the case of vector quantities.

Check whether the answer indeed represents the required physical quantity.

Check whether the numerical value is plausible.

Some problems would not require each step of strategy. For example, if a given graph had to be interpreted, it would be pointless to insist on a diagram. Sometimes problems are formulated as a series of questions, i.e. by asking the student to state some principle in (a), to draw a diagram in (b), to write down an equation in (c) and to solve for the unknown in (d). In such subdivided questions, the teacher and student should concentrate only on the relevant part(s) of the strategy.

An answer to one question often has to be used as information in the next question. This would replace an intermediate calculation: the problem would be simplified as learners need not decide for themselves which variable should be calculated before solving the real problem. However, the learners still need to decide for themselves if and where such answers need to be used.

The problem-solving strategy described above was intended to improve problem-solving performance together with development of conceptual understanding. Successful approaches reported in the literature were combined and simplified to suit the local context. The relevant approaches will be discussed in detail in chapter 2.

## **1.6 OUTLINE OF THE STUDY**

Sixteen disadvantaged urban South African high schools participated in the study. A quasi-experimental design was applied; the treatment and control groups were located in different non-interacting school districts. A pre-test was administered before starting the treatment; the two groups performed similarly on this test. The problem-solving strategy was implemented by a cascading model where the researcher interacted with the teachers, while the teachers interacted with learners. Schools in the treatment group applied the strategy throughout the school year while learning new content. The study was designed to be non-disruptive; there were no extra classes or additional work. Normal classroom tests and examinations were used as the source of quantitative as well as qualitative data. Conceptual understanding was explored in novel ways, by constructing solution maps of test problems and calculating conceptual indexes for particular solutions. Additional sources of qualitative data were questionnaires as well as videotapes of learners working on problems.

The strategy was designed to incorporate successful practices reported in the literature: using different representations, group work, verbal arguments, written explanations, planning and interpretation of solutions. The main findings were that implementation of the strategy led to more success in problem solving, enhanced conceptual understanding, and an increased use of a conceptual approach to problem solving. It should be emphasized that the strategy should not be viewed as recipe-like instructions that can be used as a quick fix in examinations. Success roots

in regular use of the strategy, by acquiring new habits involving repeated translations between Greeno's (Greeno, 1989) four domains of knowledge. The learners, therefore, became intellectually engaged by relating concrete problem situations to models, abstractions, algebraic and language representations. The extended period of implementation, namely 10 months, provided repeated episodes of such intellectual engagement. It is, therefore, proposed that the success of this strategy is based on developing conceptual understanding of physics, rather than the development of algorithmic skills.

Employment of the strategy in disadvantaged schools promises to:

- improve scores in high stakes examinations
- develop conceptual understanding of physics
- encourage learners' active participation in their learning
- develop better command of the language of instruction
- enhance professional development of teachers
- promote a culture of learning
- be a cost effective way of improving teaching and learning of physics

## 1.7 LIMITATIONS

The intervention involved teachers and learners, but assessment focused only on learners' problem-solving behaviour. Teacher development was not assessed. This choice was made for two reasons: evaluating teachers could create mistrust, and classroom observation of teacher behaviour was not possible due to personal teaching responsibilities. Consequently, the results were interpreted as implicitly containing the effects of teacher development. Conclusions should, therefore, not be extended beyond the disadvantaged environment in which the study was conducted. However, this was not the intention; the study aimed at improving the dynamics of teaching and learning of physics through a single treatment, namely structured problem solving. Implementation of the strategy should thus be viewed as an experimental treatment on whole classes, teachers included.

The role of problem solving in physics courses was not questioned. Results of this study do not suggest that problem solving is the one and only way to learn physics. What the study does suggest is that a structured approach to problem solving can be useful in promoting successful problem solving and developing conceptual understanding of physics in disadvantaged South African schools.

Influences of second language usage and classroom interaction were not explored. These issues are complicated, lying beyond the scope of the current study. A future study could investigate language and social issues in relation to problem solving in physics.

The intervention was focused on problem solving, without addressing the scientific knowledge bases of learners and/or teachers. This approach allowed the second research question, viz. the effect of the problem-solving strategy on conceptual understanding. In future implementations, efforts to develop content knowledge may be added to amplify benefits of a problem-solving strategy.

## **1.8 ORGANISATION OF THE THESIS**

Chapter 2 reviews research relevant to this study: problem solving in physics, conceptual understanding and instructional strategies. Chapter 3 describes Greeno's model as a theoretical framework to interpret the problem-solving strategy that was used in the current study. Chapter 4 outlines the research methodology, explaining how the strategy was implemented and how data were collected. Results are presented in two separate chapters. Chapter 5 focuses on quantitative data demonstrating that the treatment group outperformed the control group in tests and the examination. Chapter 6 explores qualitative evidence of enhanced conceptual understanding amongst the treatment group. Chapter 7 concludes the study, interpreting the results and discussing the merits of implementing a problem-solving strategy in disadvantaged South African schools.

## CHAPTER 2

### LITERATURE SURVEY

Physics instructors generally accept problem solving as *the* way to learn physics (Maloney, 1994; Hobden, 1999). Consequently, much research on problem solving has been conducted. Growing concern for the lack of conceptual understanding amongst students has been voiced by leading academics since the early nineteen eighties (Hewitt, 1983; McDermott 1991; Redish, 1994; Van Heuvelen, 1991a). Difficulties with problem solving in physics and conceptual understanding are aggravated in South Africa, due to the disadvantages in the school situation of the majority of the population.

This literature survey is divided into four sections, starting with studies on problem solving in physics by individuals. The next section reports on literature about the conceptual understanding of physics. Then follows a discussion of particular instructional strategies developed and implemented at various institutions. The chapter is concluded by discussing the application of research results to design a problem-solving strategy that could be suitable for the South African context.

#### 2.1 PROBLEM SOLVING IN PHYSICS BY INDIVIDUALS

In the late nineteen seventies and early nineteen eighties, research on problem solving focused on the way that individuals solved problems in physics. The philosophy was to determine the characteristics of expert and novice approaches to problem solving. It was argued that if the experts' approaches to problems could be understood, these expert approaches could be taught to the students in an effort to enhance their problem-solving abilities. The experts used in these studies were postgraduate students and professors, while the novices were first year students. The most striking difference between the experts' and the novices' approaches were found in the experts' application of *general* principles of physics which were generally not found in the novices' solutions (Maloney, 1994). The experts typically applied general principles of physics to the given situation and then worked mathematically towards the solution. The novices typically

used means-end analyses. This focused on the gap between the required answer and the information; thus filling in steps to complete an algebraic solution.

The expert-novice classes are two extremes of a grey area through which students progress in their learning. Bashkar and Simon (1977) conducted a case study on a reasonably proficient subject solving six problems in engineering thermodynamics. They reported a consistent approach, namely a combination of means-ends analysis modified by the general principle of energy conservation. A study of two subjects, one more experienced than the other, indicated that they followed different approaches when solving kinematics problems (Simon & Simon, 1978). The more experienced student worked forward from the information to a numerical answer; he started with an equation, or series of equations, until he found the unknown value. The less experienced student used a means-ends analysis, working backwards. He started with an equation containing the unknown variable, and calculated whatever was required to solve the original equation. The authors ascribed the efficiency of the solutions of the experienced problem solver to physical intuition. Maloney (1994) interpreted this intuition as the use of general principles that develops as an individual acquires a broader knowledge base.

A series of studies on experts and novices identified qualitative analysis and successive representations as characteristic of expert problem solving. Larkin (1979) observed that experts performed qualitative analysis before working equations. In a related study, the expert included a qualitative physical description between the original description and the mathematical solution; this was called a “second stage domain specific representation” (Larkin & Reif, 1979). A subsequent computer modelling study by Larkin, McDermott, Simon and Simon (1980) identified successive representations as the main characteristic of experts’ problem-solving approaches. Successive representations are useful to translate the problem statement from natural language to a mathematical form that is compatible with the mathematical expressions of the relevant principles of physics. Larkin (1983) explored the role played by representations in the solving of physics problems. She observed that novices used naive representations of physical objects, while experts used physics representations involving the concepts of physics such as forces and fields. Even for difficult problems, experts did not proceed to mathematics before constructing a suitable representation.

The expert-novice studies had a major shortcoming in the vastly different knowledge bases of the experts and novices. Comparisons between problem solving by experts and novices did not provide the opportunity to separate the influence of the knowledge base from the problem-solving skill itself. The effect of different knowledge bases was eliminated in a study by Finegold and Mass (1985). Subjects with similar content knowledge were chosen from high school students of physics in an advanced placement course. It was assumed that all students in this course had the basic content knowledge to solve the test problems. Their teachers classified the students as good or poor problem solvers, and the researchers randomly chose eight subjects on each list. Students were asked to think aloud during observation, while solving mechanics and circuit problems. The good problem solvers were found to be superior in the following aspects: correctness of translation; planning; less time taken to complete task; proportionately more time spent on translation and planning; better reasoning in physics. This study indicated that problem solving is a skill that can differ for individuals with similar knowledge bases.

The expert-novice studies not only explored problem-solving approaches, but also knowledge organization. Larkin (1979) found that additional instruction on how to organize relations improved students' performance in solving problems where more than one relation was involved. Hierarchical knowledge structures were shown to be related to superior problem solving in complex problem-solving tasks (Eylon & Reif, 1984; Reif & Heller, 1982). Fergusson-Hessler & De Jongh (1987) found that good novice problem solvers had their knowledge organized according to problem schemata and proposed that explicit encouragement of such schemata would assist the eventual development of the hierarchical knowledge structures associated with experts. The current study did not attempt to assess or improve the knowledge base of students and/or teachers. It was argued that such attempts would interfere with the investigation aimed at exploring the effect of implementing structured problem solving. For classroom practice, it should be kept in mind that combining instruction on knowledge organisation and structured problem solving would probably lead to even better results (Van Heuvelen, 1991b; Wright & Williams, 1986).

The studies on problem solving by individuals produced results that were implemented in the design of the strategy used in this study. As in problem solving by experts, the choice of equations follows from the relevant general principles that were identified in the analysis. The means-ends approach of novices does not fit the steps of the strategy – instead the steps guide the student through successive representations that characterise expert problem solving. It was argued that if students could be guided to behave like experts, they would develop the thinking patterns associated with expert behaviour.

## **2.2 CONCEPTUAL UNDERSTANDING OF PHYSICS**

Instructors and teachers of physics are well aware of students' persistent difficulties in understanding physics. Often, students can solve problems, but are unable to explain the meaning of their solutions. An overwhelming volume of research has been reported on specific difficulties, preconceptions and misconceptions in practically all of the topics taught in typical first year courses. An extensive overview of research on physics education, including research on students' difficulties, was published by McDermott and Redish (1999). In the current section the focus is on conceptual understanding in relation to problem solving.

McMillan and Swadener (1991) investigated conceptual understanding of successful novice problem solvers. Six volunteers were observed solving an electrostatics problem with two possible solutions, namely an unknown charge being either positive or negative. Five of the students obtained a correct solution by interpreting the information assuming the unknown charge to be positive. What was disturbing, however, was that they could not explain the meaning of the second solution that would correspond to the unknown charge being negative. This result suggested that students learn to solve standard problems in physics without applying conceptual and interpretative knowledge. The well-known Force Concept Inventory (Hestenes, Wells & Swackhamer, 1992) was a direct result of a study showing that students enter college with inadequate preconceptions of physics (Halloun & Hestenes, 1985a, 1985b). McDermott and Schaffer (1992) reported on an ongoing coordinated research programme by the physics Education Group at the University of Washington to design instructional strategies that would address student difficulties. A study on teaching simple circuits indicated that conceptual



difficulties were not adequately addressed in traditional lecture and laboratory format. Regarding problem solving, McDermott (1991) argued that successful problem solving did not necessarily imply that a corresponding level of conceptual understanding was reached. Poor conceptual understanding was demonstrated by various studies: students were unable to relate algebraic formalism of work-energy and impulse-momentum principles to observation (Lawson & McDermott, 1987); successful numerical solutions of circuit problems did not guarantee a corresponding level of qualitative understanding (Schaffer & McDermott, 1992); interviewing students demonstrated that correct responses to multiple-choice items were insufficient indicators of understanding (Pride, Vokos & McDermott, 1998).

The discussion above is just the tip of the iceberg, but sufficient to show the need for efforts to improve students' conceptual understanding. It is clear that the teaching of physics at high school and university frequently does not succeed in developing understanding of the principles of physics. Students can recite principles, solve problems, and pass examinations – yet they struggle to explain how principles of physics relate to reality; they are unable to interpret algebraic solutions and they still hold misconceptions. We as teachers should ask ourselves what is wrong with our way of teaching, and how we can improve our practices. Many suggestions and claims have been published. Hewitt (1983) claimed that development of conceptual understanding is actually obscured by problem-solving instruction in high school. Van Heuvelen (1991a) remarked that in the traditional lecture situation, students of physics are passive observers while instructors tend to demonstrate the entire game – transmission of knowledge is perfect but reception almost negligible. Conventional instruction does not provide opportunities for meaningful conceptual change. Learning new concepts requires adding new knowledge and adjusting prior knowledge. New concepts need to be intelligible, plausible and fruitful (Posner, Strike, Hewson & Gerzog, 1982) to be incorporated into an existing set of ideas. Students are usually unwilling to make changes in existing ideas, unless sufficient dissatisfaction develops. The lecture situation, or teacher dominated instruction is ill suited to confronting students with inadequacy of existing ideas as it doesn't give opportunities to argue and interact. Therefore, new ideas seldom become part of students' conceptions in the classroom.

How should classroom practices be adjusted to ensure that students learn to understand physics? Clearly, the lecture format is not a suitable environment for learning to understand physics. Successful learning in the classroom is possible when individual as well as social construction of knowledge are involved (Duit, Roth, Komorek & Wilbers, 1998). Hewitt (1983: 306) advocated that students should be taught to conceptualize before learning to compute, also that discussions amongst students should be encouraged, because "... ideas we only think about, we tend to forget. But ideas we discuss, we remember". He suggested that conceptual reasoning should form part of examinations in order to encourage students to conceptualise. Redish (1994) argued that physicists should learn from cognitive science, particularly constructivism and conceptual change, to improve their teaching. This ultimately requires the teacher to guide the student to learn, rather than to attempt to *give* knowledge. Redish recommends that students should be given opportunities to do qualitative reasoning, to construct mental models, and to learn to apply their models. According to Van Heuvelen (1991a), physicists depend on qualitative analysis to understand and help construct mathematical representations of physical processes. He suggested that students could learn to think like physicists when given opportunities to reason qualitatively and make use of translations from verbal, pictorial, and physics representations, before switching to the mathematical form.

Problem solving can be instrumental in developing conceptual understanding. Fraser, Linder and Pang (2004) used the technique of variation, challenging students to find alternative ways of doing the same problem, thus creating a richer understanding of physics. Alant (2004) regarded familiarity with problems as a basis for conceptual understanding. Recognising a problem entails personal involvement and the possibility to pay particular attention to critical aspects. Thus familiarity with a problem does not necessarily imply repetition; it can serve as a "springboard for students to go beyond confirming convention" (Alant, 2004: 37). On the other hand, instruction focusing on problem solving often ignores intellectual objectives (McDermott, 1991). Therefore, students could learn to concentrate on algorithms instead of physics. McDermott suggested that students should be intellectually engaged in the learning process in order to bring about significant conceptual change; such mental engagement could be developed when students are required to explain their reasoning in their own words.

The studies discussed above provided insights that were utilized in the design of the problem-solving strategy used in the current project. The step “analysis” creates opportunities for students to become intellectually engaged, to formulate arguments in classroom discussions and in writing in order to identify principles of physics that could be applied to a particular problem. The final step, “interpretation”, returns the focus to the concrete meaning of a mathematical solution. The steps therefore create opportunities for social and individual construction of knowledge, to understand how physics concepts relate to concrete problem situations.

## **2.3 INSTRUCTIONAL STRATEGIES**

Well-specified instructional strategies for the teaching of physics have been employed at various institutions. Some of these strategies developed from research on problem solving, while others were aimed at conceptual development.

### **2.3.1 Structured problem solving**

Polya (1948) was the first to suggest the use of a structured approach to problem solving. His strategy, designed for mathematics, consisted of 4 basic steps, summarized as:

- understand the problem
- devise a plan
- carry out the plan
- look back

While working through the four steps, the student and teacher had to ask numerous questions, which would develop conceptual understanding of the problem.

Polya’s four steps can be recognized in an early study conducted at the University of California (Reif, Larkin & Bracket, 1976). Students' inefficient and haphazard solutions led Reif, Larkin and Bracket to teach a simple problem-solving strategy. The following steps were recommended:

- description (diagram and information)
- planning (select relations and process)
- implementation (do calculations)
- checking

Assessment of the effect of this strategy was based on detailed observation of individual students in small groups, rather than using a statistical approach. The authors reported that the students used more diagrams and effective algebra, did better planning and were more successful at obtaining correct solutions than students in ordinary physics courses. Furthermore, they tended to do some reasoning and used relevant steps even when they did not obtain the correct solution. It was concluded that explicit instruction of cognitive skills and a problem-solving strategy contributed to better student achievement in physics. This early study led to numerous studies on individual problem solving, hierarchical knowledge organizing schemes, information processing and instructional strategies.

### **2.3.2 Explicit problem solving**

Reif and Heller (1982) argued that problem-solving strategies should be taught explicitly, because of the complicated nature of cognitive mechanisms used in problem-solving structures. Their approach was named a prescriptive approach to problem solving, and designed for effective problem solving for novices, without attempting to mimic expert problem solving. This prescriptive model focused on theoretical descriptions of problems, and was subsequently tested on 24 undergraduates, in the domain of mechanics (Heller & Reif, 1984). Results indicated that the students using the prescriptive model performed better than the control group, leading to the conclusion that the prescriptive model was sufficient and effective.

At the Tidewater Community College, Wright and Williams (1986) developed the Explicitly Structured Physics Instruction (ESPI) system. The most important element of ESPI was the WISE problem-solving strategy, which involved the following steps:

- what's happening

- isolate the unknown
- substitute
- evaluate

The ESPI system also involved Formula Fact Sheets. These described the symbols in the equation and showed common uses thereof. The WISE strategy and the Formula Fact Sheets were regarded as complementary aids to relate principles to physical situations: while the strategy starts with a physical problem situation, a formula fact sheet starts with an equation followed by typical applications. Another aspect of ESPI involved problem-solving sessions where thoughts had to be vocalized to promote thoroughness. The programme was developed over three quarters and then tested in final form for three quarters. There was no traditional control group, since the study was not meant to prove the system better than something else. Students were interviewed for two quarters and questionnaires were administered for four quarters. The relationship between pre-math test scores, use of strategy and final grades were investigated. The data showed that the students who used the strategy frequently did very well in the course. Students were generally positive about the ESPI system. The success was measured as an improvement from 77 to 85% in the retention rate when compared to the best of the previous ten years. The retention rate referred to the percentage of students ending the year with at least a D symbol.

### **2.3.3 Structured problem solving and cooperative groups**

Structured problem solving was combined with cooperative grouping at the University of Minnesota (Heller, Keith & Anderson, 1992). The five-step strategy was strongly influenced by the work of Reif and Heller (1982) and Schoenfeld's (1985) approach to problem solving in mathematics. The students had to make a systematic series of translations of the problem into different representations, becoming more abstract and mathematically detailed. The five steps were summarized as: visualize the problem; physics description; plan a solution; execute the plan; check and evaluate the solution.

The strategy was taught early in the first quarter and subsequently modelled in all lectures. Context-rich problems were constructed to encourage students to apply the strategy. The authors used the term “context-rich” problems to describe problems that require some qualitative reasoning and the use of conceptual knowledge of physics. The students were reluctant to use this strategy in typical textbooks problems - they resorted to manipulating equations without following the strategy. Students took a total of seven tests, each test consisting of a group section and an individual section. Problems in the two sections were matched in difficulty.

The study showed that group solutions were significantly better than the solutions of the best individual problem solver in the group and that the individual problem-solving ability had improved. Finally, the study seemed to indicate that conceptual understanding was enhanced by the instructional approach, but this claim had not been tested.

#### **2.3.4 The classroom based study of Huffman**

Huffman (1997) conducted a classroom-based study on structured problem solving in high school physics. The aim of this study was to establish the effect of an *explicit* problem-solving strategy on problem-solving performance as well as on conceptual understanding. The explicit problem-solving strategy described by Heller et al. (1992) was compared to a so-called textbook strategy. The treatment group used the explicit strategy that emphasized both qualitative and quantitative aspects of problem solving. On the other hand, textbook strategies tend to emphasize only quantitative aspects. The control group was taught the so-called textbook strategy consisting of the following five steps:

- draw a sketch
- define known and unknown quantities
- select equations
- solve equations
- check the answer

Eight classes with a total of 145 students participated in the study. Four classes with two teachers acted as the treatment group while the remaining four classes with the same two teachers acted as

the control group. Students were randomly placed in either the treatment or the control groups. The study was conducted over one semester and consisted of two stages. During the first stage, each group was taught how to implement the strategy assigned to the particular group. In the next stage, both groups were taught an identical unit on Newton's laws. The students participated in weekly cooperative group problem-solving sessions. Students in the treatment group had to solve context-rich problems, while the control group was given typical two-step textbook problems. At the end of the semester, both groups were given a problem-solving test comprising of context-rich problems and textbook problems. Conceptual understanding was assessed in pre and post-tests.

Surprisingly, the problem-solving ability was similar for both groups. However, the treatment group did show an improvement in the quality and completeness of the physics representations used in their problem solving. Mathematically, the solutions for the two groups were of the same quality. The conceptual understanding of females improved in the treatment group while that of males improved in the control group, which is indicative of some resistance by male students towards the explicit strategy.

### **2.3.5 Modelling Instruction**

Halloun and Hestenes's (1985a, 1985b) investigations of first year college students' preconceptions led to a model-centred approach aimed at improving instruction in problem solving (Halloun & Hestenes, 1987). The approach entailed the selection of a set of paradigm problems, suitable to challenge misconceptions and also to require a complete set of modelling techniques. These paradigm problems were solved by a dialectic teaching strategy (Hestenes, 1987) in order to engage students in arguments through which conflicting ideas could be resolved. The classroom discussion of issues around the paradigm problems thus created opportunity for conceptual change. The modelling approach subsequently developed into the Modelling Instruction Program at the Arizona State University (Halloun, 1996). This was a laboratory-based methodology by which students collected data in order to construct models to represent kinematic and causal models. The modelling cycle consisted of two phases, namely development and deployment. The development phase imitated the scientific process while the

deployment phase focused on mathematical problem solving. Student dialogue was emphasized in both the development and deployment phases. Reichling (2003) observed that although this modelling programme was widely implemented, the primary outcome was a descriptive mathematical model that did not always provide students with enough opportunity to develop contextual, explanatory models.

### **2.3.6 Overview, Case Study physics**

The Overview, Case Study approach implemented at New Mexico State University, integrated various techniques in a course that focused on problem solving (Van Heuvelen, 1991b). These techniques included multiple problem representations, active development of hierarchical charts, case studies, overviews, problem learning sheets and classroom interactions between neighbouring students. Substantial gains were reported in test scores for qualitative as well as quantitative questions. Furthermore, scores on quantitative questions seemed to improve when students integrated qualitative representations into their quantitative problem solving.

### **2.3.7 Qualitative strategy writing**

Writing can be a valuable learning exercise, as the formulation of ideas contributes to ownership thereof. The writing-to-learn movement advocated informal writing done regularly in class (Connolly, 1989). Connolly proposed that the conceptual understanding of science could be developed by informal, tentative writing that allows students to think for themselves.

The writing-to-learn philosophy was employed in the qualitative problem-solving strategy used at the University of Massachusetts (Leonard, Dufresne & Mestre, 1996). Lecturers and students were required to write discussions of the what, why and how before attempting mathematical solutions to physics problems. The written strategies need to contain the following:

- identification of the major principle or concept that can be applied to solve the problem
- justification of why the principle/concept can be applied
- procedure by which the principle/concept can be applied to solve the problem



It was concluded that strategy writing improved conceptual understanding and that it was a valuable diagnostic tool. Students were able to identify principles required for solving problems and to recall major physical principles months after completion of the course. The authors argued that the success of their approach was in the separation of the written strategy from the solution; which emphasized physics rather than algebra.

### 2.3.8 Summary

What can be learnt from the instructional strategies discussed above?

- Problem-solving strategies, which included qualitative analysis and multiple representations, resulted in better problem solving.
- Cooperative group problem solving showed that group solutions were superior to the best individual efforts.
- Strategy writing was shown to develop problem-solving skills as well as conceptual understanding.
- Modelling instruction provided opportunity for students' interaction to resolve conflicting ideas – adjusting and extending their concepts while constructing solutions.

The strategies discussed above produced enhanced learning. However, the possibility exists that any strategy could be implemented as an algorithmic procedure, instead of being focused on the physics involved. A strategy should bring students closer to understanding how principles of physics apply to concrete problem situations. McDermott's call for intellectual engagement should be taken seriously.

Padgett (1991), a schoolteacher, compiled a list of 33 steps from teacher's notes and textbooks on how to solve problems. She remarked that most sources agree that there are about six steps in good problem solving but that there was no agreement on what those steps were. She warned against rigid use of strategies at the cost of the art of problem solving and the understanding of physical principles.

## 2.4 IMPLICATIONS FOR SCIENCE EDUCATION IN SOUTH AFRICA

The research on individual problem solving, conceptual understanding and instructional strategies was utilized in an attempt to improve the poor state of science education in disadvantaged South African schools. In the current study, the use of multiple representations, social and individual constructivism, and the writing-to-learn philosophy were integrated into a simple problem-solving strategy that could be implemented in the classroom and in individual problem solving. The steps of the strategy require activities that could introduce meaningful intellectual engagement in science classrooms. Expert problem solvers may regard the strategy as trivial, but it could be a guide out of the desert of teacher dominated science lessons. An opening statement like “the formula is...” could be replaced with an activity of representing the real situation in a diagram, adding physics concepts, representing information and unknowns on the diagram. Then a plan must be formulated. In the social setting of the classroom, the shaping of understanding can be improved through the challenging and changing of ideas and the formulation of arguments. The plan must also be written down, providing opportunity of individual knowledge construction. Only after the plan has been written down, can the mathematical solution start. Most of the activities thus focus on relating the concrete reality of the problem situation to principles of physics. Algebra plays a minor role – it is applied to find numerical answers, nothing more. Finally, the numerical answer has to be interpreted in terms of the given real world situation, completing a journey from reality to physics and back.

The step analysis creates new opportunities in disadvantaged classrooms. Students’ participation in the planning, reasoning, and argumentation can be a mechanism through which the role of the teacher can be changed from that of expositor to that of facilitator. Furthermore, conceptual and language development can occur simultaneously. Roth (1996) argued that knowledge and language develops simultaneously, in small steps, such that knowledge and language become constitutive of each other. The classroom and group discussions thus promise conceptual development amongst second language users.

Two of the successful practices discussed above, were not fully included in the proposed strategy. Firstly, no distinction was required between real world diagrams and physics diagrams

as used by the Heller-group (Heller, Keith & Anderson, 1992). It was argued that separate diagrams could distract attention from the effort to learn to relate physics to reality. In fact, experienced problem solvers sometimes draw forces on top of objects in real world diagrams, thus making abstract physics concepts visible in their real world location (Larkin & Simon, 1987). Secondly, the modelling method was limited to classroom problems; the sophisticated development of physics content knowledge through modelling cycles (Halloun, 1996) was beyond the scope of this project – it could even lead to an undesirable focus on the mathematical aspects of models (Reichling, 2003).

Most of the strategies discussed above, recommend symbolic solutions before substitution of numerical values (Reif, Larkin & Bracket, 1976; Wright & Williams, 1986; Huffman, 1997). In the current study, students were encouraged to substitute numerical values before starting algebraic manipulation. The reason being, that the poor mathematical abilities of disadvantaged students could prevent many students from arriving at correct symbolic solutions. It is argued that wrong symbolic solutions would not develop insight into the relevant relationships, and numeric substitutions into such symbolic solutions would be meaningless, adding to confusion. Emphasis on symbolic solutions could, therefore, be counterproductive for students with poor mathematical skills.

Is the proposed problem-solving strategy a viable possibility in disadvantaged South African classrooms? Johnson, Monk and Hodges (2000) argued that in disadvantaged classrooms, modest steps could move teachers towards professionalism. The seven-step strategy used in this study is indeed a modest step. It is learner centred and it does not envisage major retraining of teachers, expensive equipment or new syllabi. Instead, it encourages active participation of teacher and students, social interaction and intellectual engagement structured around activities as guided by the steps. This can enable teachers, together with their students, to develop a better understanding of physics, while learning to solve problems.

## CHAPTER 3

### THEORETICAL FRAMEWORK

Much has been written and said about the mismatch between successful algebraic problem solving and conceptual understanding of the phenomena related to the problem. It is well known that many students can solve problems without being able to explain the meaning of solutions and that they can use physics formulae but are unable to apply the underlying principles of physics to concrete situations. How do these algebraic solutions become disconnected from reality? How can such disconnectedness be remedied?

This chapter aims to shed light on these two questions. Firstly, Greeno's model (Greeno, 1989) is discussed as a framework that explains the disconnection between algebraic problem solving and conceptual understanding. Secondly, the problem-solving strategy used in the present study is interpreted in terms of Greeno's model to demonstrate how application of the strategy can develop both problem-solving skills and conceptual understanding.

#### 3.1 GREENO'S MODEL FOR SCIENTIFIC PROBLEM SOLVING

In work on information processing, Greeno (1989) proposed a framework to analyse cognition relevant to scientific problem solving and reasoning. His model was called the extended semantic model and was based on four domains of knowledge, namely:

1. concrete domain (physical objects and events)
2. model domain (models of reality and abstractions)
3. abstract domain (concepts, laws and principles)
4. symbolic domain (language and algebra)

One-to-one correspondences exist between the domains. For example, the physical situation of a crane lifting a container corresponds to a force diagram in the model domain, the concepts of forces and Newton's second law in the abstract domain and language as well as algebraic

descriptions in the symbolic domain. According to Greeno, scientific problem-solving and reasoning skills involve the realization of the correspondences between these domains. Chekuri and Markle (2004) argued that although problem solving in physics usually implements algebra (operations in domain 4), a learner should always be in touch with the other three domains to consolidate concepts.

The four domains are represented in figure 3.1. The correspondences (mappings) between the domains are indicated by  $\Phi$ , with subscripts c, m, a, s respectively denoting the concrete, model, abstract and symbolic domains. For example,  $\Phi_{sc}$  represents the mapping between the symbolic and concrete domains. Figure 3.1 also shows a double-layered structure of each of the four domains as well as connections indicated by  $\theta$  and  $\Psi$ , within domains. These features are discussed below.

Each domain consists of two layers, namely an a-layer containing independent items, or pieces of knowledge, while the associated b-layer contains structures of items, i.e. meaningful combinations, or structures of the pieces of knowledge. Using the crane example, in the concrete domain, layer 1a contains items like crane, cable, container and the action of lifting, while the combination of the crane lifting the container is a structure in layer 1b. In the model domain, arrows and a dot/circle/square are items in layer 2a, while the force diagram combining these as vertical arrows attached to the dot/circle/square, one arrow pointing up and the other pointing down, is the structure in layer 2b. In the abstract domain, the concepts of force, mass, weight and acceleration belong in layer 3a, while Newton's second law is a structure in layer 3b. In the symbolic domain, symbols like F, m, g and a are items in the 4a layer, while the formula  $\Sigma F = ma$  is a structure in the 4b layer. A written problem statement about the crane lifting the container is another structure in 4b, while the independent words are items in 4a. An example from electrical circuits is given in table 3.1 to illustrate how independent items in a-layers are combined into meaningful structures in the associated b-layers.

Figure 3.1 also shows connections within each domain, indicated by  $\theta$  and  $\Psi$ , with subscripts c, m, a and s to indicate the relevant domain. Connections marked  $\theta$  represent relationships between independent items in a layers to form meaningful structures in the corresponding b-

layers. For example, a connection  $\theta_m$  in the model domain can represent the rules for how to draw a circuit diagram from components, or the parallelogram rule to add vectors. Connections marked  $\Psi$  represent alternative ways to represent a particular structure in a particular layer, governed by sets of rules for the particular domain. For example, to associate a constant velocity with a zero resultant force is an operation  $\Psi_a$  in the domain of abstract structures. Another relevant example is algebraic manipulation, classified as an operation  $\Psi_s$  in the symbolic domain.

Figure 3.1. Greeno's four domains of knowledge for scientific problem solving, shown with connections between domains as well as connection within domains (Greeno, 1989: 310).

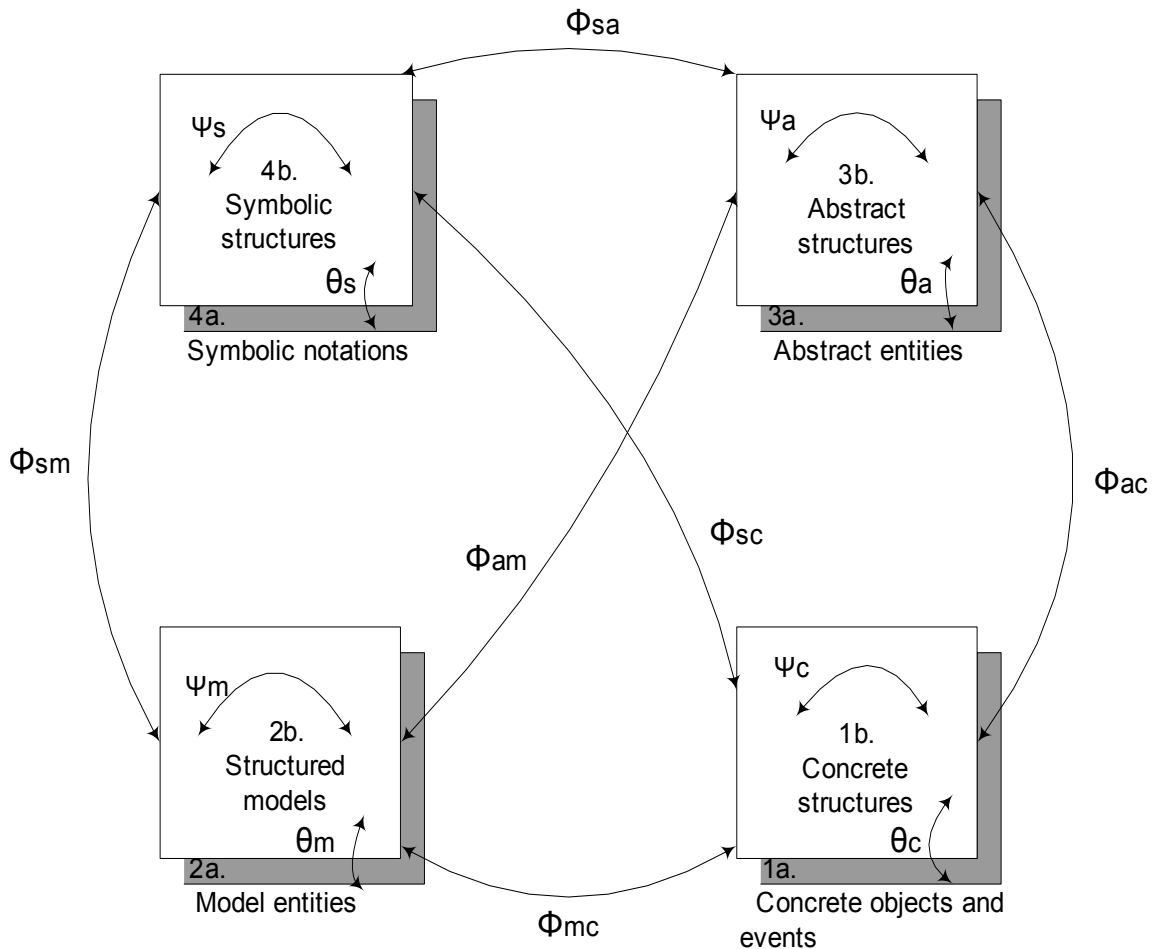

Table 3.1 Knowledge of electrical circuits interpreted in terms of Greeno's model.

Domain	Description	Layer	Examples
1	concrete	1a	bulbs, cells, wires, voltmeter, ammeter
		1b	electrical circuit
2	models	2a	diagrams of circuit components
		2b	circuit diagram
3	abstractions	3a	resistance, current, potential difference, volt, ohm, ampere
		3b	Ohm's law
4	symbolic	4a	words and symbols like R, V, I, $\Omega$ , A
		4b	sentences and equations e.g. $R = V \div I$

In contrast to idealised problem solving that incorporates all four domains of knowledge, a popular formula-based approach flourishes amongst students. This technique is popularly known as the plug-and-chug method, described by Heller and Heller (1995). The students tend to start with a data list, matching information to symbols. This is followed by selecting a suitable formula to link the unknown symbol to the known symbols in the list. All that remains is to substitute and to solve algebraically; interpretations are rare. Van Heuvelen (1991a) called this method a formula-based approach. Greeno (1989) referred to the “insulation” of the symbolic world from the “situated nature” of problems to explain how algebraic solutions can become disconnected from the concrete situation they represent. In the classroom, students manipulate symbols to solve problems while the concrete problem situation is seldom present. This classroom reality can, therefore, lead to the belief that problems are about the symbols, rather than about the concrete situation represented by those symbols. The symbols are real marks on paper and the chalkboard, taking the place of the real objects described by the problem statement. Figure 3.2 illustrates the “insulation” of the symbolic world: A mathematical operation  $\Psi_s$  in the symbolic domain acquires the status of a mapping  $\Phi'$  from the symbolic to the concrete marks on the chalkboard and paper. Greeno refers to this inappropriate mapping as a

“perverse” mapping from symbolic structures to symbolic entities. Algebraic solutions can therefore amount to operations on knowledge located only in the domain of symbolic knowledge, without translation to the concrete or abstract domains. Such an approach can sometimes lead to correct equations and correct numerical answers, but it does not demonstrate or develop understanding of the meaning of algebraic solutions.

Figure 3.2. Greeno’s explanation of insulated algebraic problem solving (Greeno, 1989: 296).

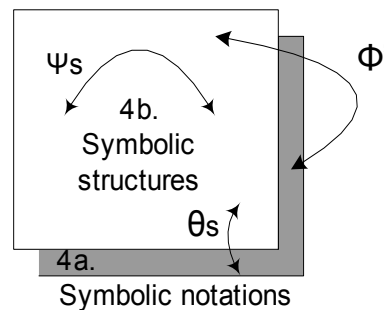

### 3.2 THE PROBLEM SOLVING STRATEGY INTERPRETED IN TERMS OF GREENO’S MODEL

Each of Greeno’s four knowledge domains features in the problem-solving strategy (outlined in 1.5) implemented in the current study. When applying the strategy, various actions are performed. These actions can be described as operations in domains and translations from one domain to another. The word “operate” means working on structures within a domain, e.g. algebraic manipulation of an equation would be an operation in the symbolic domain while manipulation of a diagram would be an operation in the model domain. “Translate” means to switch representations, to relate knowledge from one domain to another, e.g. to draw a diagram that represents a concrete situation is a translation from the concrete to the model domain. The series of actions described in table 3.2 represents the application of the problem-solving strategy interpreted in terms of translations between the four domains of knowledge.



Table 3.2. Activities required by using the problem-solving strategy interpreted as translations among Greeno's four knowledge domains.

Step of strategy	Detailed description of activity	Translations between domains
Diagram	Visualise the concrete situation described in the written problem statement.	4 to 1
	Draw a diagram to represent the concrete situation.	1 to 2
	Identify abstract concepts related to the diagram.	2 to 3
	Indicate abstract concepts on the diagram in appropriate format e.g. double arrows for accelerations.	3 to 2
	Identify the standard symbols for the relevant abstract concepts shown on the diagram.	2 to 4
	Label concepts on the diagram using standard physics symbols.	4 to 2
Information	Identify concepts for which data are specified in the problem statement.	4 to 3
	Add data to the diagram.	3 to 2
Unknown	Identify the unknown concept specified in the problem statement.	4 to 3
	Identify the standard symbol for the unknown concept	3 to 4
	Indicate the unknown on the diagram.	4 to 2
Analysis	Identify parts on the diagram that represent different phenomena in the concrete situation.	1 to 2
	Identify laws of physics that are relevant to different parts on the diagram.	2 to 3
	Identify variables that link the different parts on the diagram.	2 to 3
	Explain in writing how the problem can be solved.	3 to 4
Relationships	Write the appropriate principle(s) of physics and links as algebraic equation(s).	3 to 4
Substitute and solve	Collect information from the diagram, substitute into the equation(s) and solve.	2 to 4
Interpretation	Interpret the meaning of the symbolic answer in terms of the concrete situation.	4 to 1

The actions involved in the seven steps of the problem-solving strategy thus require making multiple translations among all four domains. This forms a wealth of different kinds of associations to synthesise reality, models, concepts and symbols. At the same time algebraic manipulations within the symbolic domain become a relatively small part of problem solving. Instead, the diagram becomes the focus of attention.

While drawing the diagram, the concrete situation described in the problem statement is reconstructed as a two-dimensional map. Concepts, information and unknown quantities are grouped by location when superimposed on the diagram. In the analysis, these localized groupings guide the search for principles of physics applicable to different parts of the concrete situation. Links between different parts of the problem become visible as shared features between groupings on the diagram. From here onwards the solution proceeds algebraically, until the symbolic solution is interpreted in terms of the concrete situation, confirming the relation between the symbolic and concrete domains.

Regular practice in using the seven-step strategy for solving problems would thus amount to practice in traversing the four knowledge domains, instead of focusing on the symbolic domain. New associations can be made to develop understanding of how physics concepts are relevant to concrete situations. Existing associations can be reinforced to develop familiarity with how physics concepts are relevant to concrete situations (Alant, 2004). Consequently, the seven-step strategy is much more than a guide to constructing solutions: it is a process to develop skills to translate between knowledge domains, to integrate relevant knowledge structures from different domains, thus enhancing conceptual understanding and problem-solving skills.

## CHAPTER 4

### RESEARCH METHODOLOGY

#### 4.1 DESIGN OF THE STUDY

A quasi-experimental design with a pre-test and post-tests was implemented. The treatment and control groups were situated in two geographically separate education districts. Each group consisted of 8 volunteering schools, with one participating teacher per school. This design differed from the Huffman (1997) study where each teacher had classes in the treatment as well as in the control groups. In the present study, the two groups were not informed about each other and because the districts were at opposite ends of town (separated by about 40 km / 25 miles), diffusion, contamination, rivalry and demoralization were effectively prevented. The study was conducted over a period of ten months, starting at the beginning of the academic year in January.

The teachers in the treatment group were introduced to the structured problem-solving strategy at an afternoon workshop early in the year. During this workshop the strategy was explicitly described and demonstrated, using sample problems taken from final grade 12 departmental examinations. At their schools the teachers explicitly explained the strategy to the students. Thereafter they applied the strategy in the classroom when solving sample problems and whenever assisting students. The students were required to apply the strategy not only when working on their own, but also in the social context of classroom sample problems and group work. Care was taken to ensure that the teachers knew exactly what was expected of them. During the first semester, three teacher workshops of 90 minutes each were held before starting new topics. Typical problems were discussed during these workshops, giving teachers the opportunity to practise using the problem-solving strategy for particular topics. The researcher provided no written solutions to problems in order to encourage teacher participation. The teachers were, therefore, actively engaged, contributing to the construction of solutions during the workshops. Similarly, the students were expected to be active participants in the classroom situation.

The control group teachers and students were informed that the purpose of the project was to investigate students' problem-solving skills. No mention was made of a treatment group using a problem-solving strategy.

The study was designed to be non-disruptive: the way in which problems were solved in the treatment group was the only change from an ordinary school situation. The problem-solving strategy was applied and practised while solving classroom and homework problems that would form part of the ordinary routine of learning physics by doing problems. The ordinary grade 12 syllabus and the school's textbooks were used. No extra classes for students were required. Tests were structured like ordinary 30-minute classroom tests consisting of typical exam problems. For each syllabus topic, a problem collection was given to the teachers of both groups to ensure that the students had the same exposure to problems. The researcher did not provide solutions to these problems to either group in order to prevent rote learning of model solutions in either group and to provide opportunities for each group to practise problem solving.

Participating in the study could benefit teachers as well as students from both groups. Students and teachers were exposed to the correct test and marking standard. Teachers did not have to set or mark tests from January to June, as this was done by the researcher in order to ensure a uniform standard. Problem collections were provided for all the topics. The fixed test dates provided a time schedule to enable teachers to finish the syllabus. The treatment group had the additional benefit of learning and implementing the problem-solving strategy.

Treatment fidelity was checked by means of questionnaires, students' written solutions and videotaping students while solving problems. Sustained classroom observation was not considered an option, as the researcher was employed as a full time teacher at the time of data collection. Besides, the presence of an observer may have caused distractions, or it could have been a threat to the teacher's authority, or it could have encouraged a special effort by the teacher and class. Whatever the effect of the presence of the observer, it could lead to a biased interpretation of results.

## 4.2 SAMPLE

Schools from disadvantaged urban areas were invited to participate in the study. In all these schools, instruction is in English, the second language of most, if not all students. Nineteen schools responded; in the end, 16 completed the project.

Schools were not randomly assigned to the treatment and control groups. Instead, all schools in the district on one side of town were invited to participate in a project using a prescribed problem-solving strategy, thus forming the treatment group. All schools in the district at the opposite end of town were invited to participate in a study on students' problem-solving skills, thus forming the control group. This geographical separation of groups was introduced to prevent contamination of the control group. Furthermore, demoralization of the control group was not a factor as they were not aware of a problem-solving strategy being tested elsewhere. The lack of randomness in assigning schools to groups was compensated for by a pre-test that confirmed equivalence of the two groups. Which of the two groups would be the treatment group? The choice was not random, but rather determined by convenience. Since there were workshops for the treatment group teachers, but not for the control group teachers, it would be more convenient to have the treatment group closer to the researcher's school.

School information summarized in table 4.1 demonstrates equivalence of the two groups. The schools were coded to ensure anonymity. Achievements ranging from excellent to very poor were found in both groups. School pass rates refer to performance of these schools, including all subjects, in the final departmental exam in the year 2000. At all schools only one teacher was involved. Teacher qualification and school status are also indicated, showing an equal number of degrees and diplomas in each group. A diploma qualification refers to a two-year teaching diploma at a teacher training college, while a degree refers to a four-year qualification from a university. This implies a three-year degree followed by a one-year teaching diploma. Although half of the teachers from each group seemed to be well qualified in terms of having degrees, none of them took physics as their major subject. There was even one teacher (from the treatment group) who did not take physics as subject for her degree at all. All the diploma teachers obtained their two-year diplomas from teacher training colleges from the apartheid era.

With one exception, all took physics as major, but the standard of these diplomas is questionable. In short, none of the teachers, whether they had degrees or diplomas, were qualified to teach physics at grade 12 level.

*Table 4.1. School information.*

<b>Group</b>	<b>Code</b>	<b>School Status</b>	<b>Teacher qualification</b>	<b>Pass rate %</b>	<b>Number of candidates</b>
Treatment	T1	private	degree	99	49
	T2	public	degree	41	30
	T3	public	degree	56	14
	T4	public	diploma	70	20
	T5	public	diploma	89	12
	T6	private	degree	93	9
	T7	public	diploma	30	34
	T8	public	diploma	58	11
Control	C1	public	degree	83	45
	C2	public	diploma	30	22
	C3	private	degree	66	29
	C4	private	diploma	78	31
	C5	public	degree	33	24
	C6	public	diploma	47	4
	C7	private	degree	100	10
	C8	public	diploma	30	5

Table 4.1 also shows the number of candidates per school, based on students who took the pre-test. Why did the numbers vary so much? Subjects can be taken on either the higher or the standard grade, and the choice is often dictated by individual schools' policies. For this study, only higher-grade students were included because standard grade physics focuses on elementary

problems that would not be suitable for a study on problem solving. Some schools allow only the best candidates to take difficult subjects like science on the higher grade to ensure a high pass rate. Such schools have large numbers of candidates on the standard grade, and very few but highly successful students on the higher grade. At the other extreme, some schools do not impose any requirements for taking subjects on the higher grade. These schools have large higher-grade groups with low pass rates. On the practical side, the students in schools with few candidates were not privileged in the sense of a small class: they were part of normal sized classes consisting of higher and standard grade students.

### 4.3 COLLECTION OF DATA

Data were collected over a period of 10 months.

The schedule is outlined below:

January:	Pre-test on vectors and kinematics
February:	Test on Newton's Laws and vertical projectiles
March:	Test on momentum/impulse and energy/work Questionnaires to students and teachers
May:	Test on electrostatics
June:	Midyear examination
September:	Preliminary examination
October:	Videotaping of volunteers while solving problems Questionnaires to test group students attending the session
November:	Teachers' questionnaire

The pre-test focused on two topics from the grade 11 syllabus, covered during the previous year. The syllabus requires that these two topics, vectors and kinematics, be also examined in the final grade 12 examination. The pre-test scores would, therefore, be an indication of knowledge and skills acquired during the previous year, while also being relevant to the coming final examination. The level of complexity of these grade 11 topics is similar to that of the grade 12 topics.

The tests were scheduled to follow soon after completing the relevant syllabus topics between February and May. The midyear examination covered the same content as the preliminary and final examinations: all grade 12 topics as well as the two grade 11 topics used for the pre-test.

The tests consisted of typical problems only, with no multiple-choice items. The June and September examinations did include multiple-choice sections, contributing one third of the total mark as is customary in the final departmental examinations. The marks for the multiple choice sections were not included in this study in order to exclude the effect that guessing could have on the results. The only exception was a direct comparison of the average scores on the multiple-choice sections, explicitly referred to as such. The June examination paper is attached in appendix 1. The tests and the June examination were all set and marked by the researcher. Before returning marked scripts to the schools, they were copied and filed for referencing.

The September examination, set centrally by the provincial department of education and marked by the teachers, served as an external standard to check the results of the study. The final examinations in November could not be used as a standard for a number of reasons: results are statistically adjusted, physics and chemistry results are combined in the final score, multiple choice sections are included in the final score, raw data for individual students are not generally available.

Videotaping problem solving in action concluded the collection of student data. All schools were invited to nominate four students of mixed abilities to participate in this session. The video problems would not be entirely new: problems similar to those given in the tests and June examination could be expected. The attendance was disappointing; only 14 students turned up, representing three schools in the test group and one in the control group. During the session, individuals were videotaped while solving problems on their own. The videos captured the problem-solving process. This could provide insight into how the strategy contributed to the construction of solutions.



The treatment group received questionnaires in March, the video group in October and the teachers in November. Multiple choice items and open-ended questions were set in order to probe beliefs and attitudes towards the problem-solving strategy. The responses could indicate whether the problem-solving strategy was a viable classroom practice.

#### **4.4 DATA ANALYSIS**

Data were analysed in several different ways, starting with statistical analysis of scores. Then followed a qualitative evaluation of all examination scripts to classify students according to their approach to problem solving. Next came a detailed analysis of all students' solutions to selected examination problems. The data analysis was then narrowed down further to case studies of solutions presented in the video session. Finally, opinions about the usefulness of the problem-solving strategy were analysed. These different layers of data analysis are outlined below.

##### **4.4.1 Quantitative**

Achievement in the classroom tests and the June examination was used as a measure of problem-solving performance. Average scores for the treatment and control groups were compared using single factor ANOVA analysis to establish whether or not the groups performed similarly. Furthermore, two-factor ANOVA analysis was applied to investigate possible interactions between the treatment and some factors relating to the students, teachers and schools.

Next, students' general approaches to problems were classified as "conceptual" or "algebraic" as a quantitative measurement of conceptualizing during problem solving. Chi-square analyses were performed to link the "conceptual approach", the problem-solving strategy and problem-solving performance.

##### **4.4.2 Qualitative**

Solution maps were developed to analyze the concepts, principles, assumptions and substitutions of physics applied in students' solutions to some problems in the June examination. These maps

explored trends amongst solutions presented by the two groups. Different trends could indicate different levels of conceptual understanding. Next, a conceptual index was defined as an indication of a group's tendency to use a conceptual approach. Finally, the conceptual index was applied to routes on the solution maps in order to establish a link between appropriate physics and a conceptual approach.

The video session data were presented as case studies, analysing the application of the problem-solving strategy.

Responses to questionnaires were summarized and interpreted to illuminate students' and teachers' attitudes and opinions about the usefulness of the problem-solving strategy.

## **4.5 INSTRUMENTS**

### **4.5.1 Reliability**

Reliability of tests refers to the consistency of results obtained using those instruments (Gall et al., 1996). In order to ensure a uniform standard, all tests and the June examination were set and marked by one person (the researcher). Copies of the tests of all students were available for external moderation. The reliability of the instruments was checked by comparing test results to the June examination results. For each student, the average score of the three tests was calculated and the correlation coefficient between these test averages and the June examination scores was calculated. This will be discussed in more detail in Chapter 5. A high degree of correlation was obtained, indicating that the test results were in good agreement with the June examination results.

### **4.5.2 Validity**

Validity refers to appropriateness (Gall et al., 1996). In the present study, validity of instruments refers to the suitability of the tests as a measurement of problem-solving performance. The type of problem referred to, was previously (Chapter 1) described as typical examination problems for

South African departmental grade 12 examinations in higher-grade physics. The researcher had several years of experience as a senior grade 12 science teacher, marker of the departmental examinations and regional examiner. Such experience gave credibility to the selection of typical examination problems in setting the tests, as well as to the standard of marking. Test problems were designed to be similar to departmental examination problems in content and difficulty. However, problems were adapted to avoid students recognizing problems.

The treatment group was not favoured by the marking schemes: Marks were allocated only for algebraic solutions in accordance with the standards used in the departmental examinations. No credit was given for written steps of the problem-solving strategy, or for any written explanations. Therefore, better scores from the treatment group would reflect only an improvement on the algebraic aspects of their solutions, as would be the case in departmental examinations. The marking of tests thus contributed to the validity of the instruments.

If tests were to be a valid measurement of problem-solving performance in the context of South African grade 12 physics examinations, both groups should have had access to those typical examination problems during their studies. Therefore, all schools participating in the project received identical sets of homework problems as preparation for each test to ensure that all students and teachers had sufficient exposure to typical examination problems on the topic. (The researcher did not provide solutions as the *teachers* were expected to interact with their students.)

While the above-mentioned measures were put in place to secure validity, they are backed up by a quantitative assessment. The September examination, set centrally by the education department and marked by the teachers, was used as an independent external measurement of problem-solving performance. The June and September examination results were compared by calculating the correlation coefficient (see Chapter 5). A high value was obtained, confirming that the June examination was a valid measurement of problem-solving performance in the context of this study.

## **4.6 VALIDITY OF THE DESIGN**

### **4.6.1 Internal validity**

Internal validity refers to the extent to which extraneous variables have been controlled by the researcher, so that observed effects can be attributed solely to the treatment variable (Gall et al., 1996). The main threat to internal validity was the possibility that pre-existing group differences could influence results.

Random assignment of students was excluded by the design that grouped schools by district. This non-random grouping had advantages that could outweigh the disadvantage of non-randomness:

- Treatment group teachers and students were not in contact with members of the control group because of the geographical separation. This excluded the possibility of treatment diffusion or contamination of the control group.
- The control group teachers and students were not informed about the existence of a treatment group using a structured problem-solving strategy. This excluded compensating rivalry or demoralization; it was expected that teaching and learning in the control group would continue as before.

Despite the lack of randomness, schools with similar backgrounds were found in both groups. Table 4.1 shows similarity in the composition of the two groups, each group comprising of 8 schools. The final word on equivalence of the groups came from the pre-test results: the average score differed by a mere 0.15% between the groups.

### **4.6.2 External validity**

External validity refers to the extent to which the results of a research study can be generalized to individuals and situations beyond those involved in the study (Gall et al., 1996).

The target population for this study was learners in disadvantaged South African schools. The sample was drawn from exactly such schools. According to Kahn (2004) 9.4% of African students taking physical science on the higher grade attend the privileged, former white schools. Therefore, the results of the study can be applicable to 90.6% of the black school population taking physical science on the higher grade.

Since 16 schools participated, it was regarded improbable that individual teachers could influence the outcome of the experiment: Chances were that good and poor teachers would be present in both groups.

Pre-test sensitization could not affect performance of the treatment group as the treatment was applied while teaching *new content*. The pre-test was based on content studied in grade 11, *before* the treatment. The treatment was administered in grade 12, while teaching *new content*. The three classroom tests were based on the *new content*, and the June examination contained less than 10% based on the pre-test content. Furthermore, the June examination results were analysed per question in order to compare the treatment effect on different topics. The grade 11 topics did, therefore, not influence conclusions on the treatment effect on the grade 12 topics. Conclusions about transfer to previously studied topics (the grade 11 topics) were clearly indicated as such.

Post-test sensitization was not considered a factor as the classroom tests and examinations were part of normal school routine; any interaction between post-tests and the treatment would be expected in the target population as well.

Novelty and disruption effects and the possibility of the treatment effect changing with time, were checked by comparing test and examination results. The tests were taken when the relevant topics were completed in February, March and May while the examination was in June.

The Hawthorne effect (Gall et al., 1996) was not considered a threat. Both groups were aware that they were being monitored, but this involvement was kept at a very low level, namely by the

marking of test and examination scripts. There were no classroom visits that could interfere with the normal teaching practices of either group.

Accurate measurement of the dependent variable, namely problem-solving performance was achieved as best as possible by restricting problems to typical examination problems. Marks were allocated only for the mathematical solution in accordance with the standards used in the provincial and national final examinations. No credit was given for steps of the problem-solving strategy, or for any written explanations. Copies of the tests of all students were available for external moderation.

In conclusion, it should be emphasized that any possible treatment effect should not be generalized for the distant future, as historic disadvantages in South Africa are expected to disappear eventually.

## CHAPTER 5

### RESULTS: QUANTITATIVE

This chapter presents quantitative evidence relating to the first research question: What was the effect of a structured problem-solving strategy in physics on test and examination scores in disadvantaged South African high schools? Section 1 reports on the composition of the sample. The next two sections analyse test and exam results: section 2 deals with scores while section 3 focuses on pass rates. In section 4, the reliability and validity of instruments are evaluated. Section 5 reports on the possibility of interactions between the treatment and some factors regarding students, teachers and schools. Section 6 defines the term “conceptual approach” to describe solutions that entail more than algebra. Examination performance is then related to the conceptual approach.

#### 5.1 SAMPLE PROFILE

A total 467 students from 19 schools started on the project. Three schools dropped out during the year, reducing the number of participating schools to 16, with eight schools in each group. During the study, some students missed tests and some dropped out. By June, only 227 students took the mid-year examination.

Students from the three schools that dropped out were excluded from the calculation of the average pre-test scores. This exclusion reduced the number of pre-test candidates to 349 students, 179 in the treatment group and 170 in the control group. The average pre-test scores of the two groups differed by merely 0.13%: the treatment group scored an average of 20.56% compared to 20.43% for the control group. These scores clearly indicated equivalence of the two groups prior to administering the treatment. The average scores of the two groups were compared by single factor ANOVA. For the pre-test group of 349 students, the critical value of F was  $F(\text{crit}) = 3.868$  at  $\alpha = 0.05$ . The null hypothesis could not be rejected, with  $F = 0.006$  and  $p = 0.940$ .

Why were the average pre-test scores so low? The students were not required to prepare for the pre-test. They knew that this test would not count towards their official year mark and that the results would be used in a research project. Nevertheless, the low scores were disturbing. It suggested that both groups remembered and understood very little of the physics they should have mastered during the previous year. In fact, the poor pre-test performance emphasized the poor academic background of these students, and the need for research towards improving the situation.

During the year, the composition of the groups changed. Some students dropped out, new students joined after the pre-test and some were absent from some tests. Students who missed any of the three post-tests or the examination were excluded from the sample to ensure that the same two groups were compared throughout the remaining part of the study. However, new students who joined after the pre-test were included to avoid unnecessary loss of data. The sample chosen this way consisted of 109 students in the control group and 80 in the test group. Table 5.1 shows how the number of students in each group changed from the pre-test to the final sample.

*Table 5.1. Number of students taking tests throughout the study.*

<b>Group</b>	<b>Took pre-test</b>	<b>Missed some tests</b>	<b>Took all tests</b>	<b>Joined after pre-test</b>	<b>Final sample</b>
Treatment	179	108	71	9	80
Control	170	105	65	44	109
All	349	213	136	53	189

Inclusion of those students who joined after the pre-test was justified as follows: equivalence of the groups was well established by the pre-test. Furthermore, the students who joined late, but kept up, would probably have performed better in the pre-test than the ones who did the pre-test but later dropped out. This argument implies that the measured pre-test scores underestimated the



ability of the groups. Such an underestimate would be larger for the control group where more students dropped out, and more students joined after the pre-test, when compared to the treatment group. Undetected initial differences in the two groups would, therefore, be to the advantage of the control group; this would not change the conclusions of the study.

The large variation of the number of higher-grade candidates in schools was already discussed in Chapter 4. In the pre-test, the class size varied from 49 to 4, with an average of 21.8 students. During the year, the number of higher-grade candidates was reduced when some students lowered their level to standard grade. There were also some students excluded from the sample due to absenteeism from tests. Finally, the class size in the sample varied from 31 to only 1, with an average of 11.8 students per school. However, the students in small classes were not privileged in the sense of a physically small class: they were part of normal classes consisting of higher and standard grade students.

The differences in class size raised the following question: Should the average performances of the treatment and control groups be calculated using equally weighted schools, or individual students? Equally weighted schools would give a relatively large contribution from small classes, which might be a result of a school selecting a small number of good students to do higher grade physics, or it might be the result of poor discipline and substantial absenteeism from tests. Whatever the reason for a class being small, the average performance of such a class might not be a true reflection of the performance of a normal class. The possible over-representation of small classes on the total result can be reduced by having individual students from different schools contribute equally; this approach was followed in the current study.

## **5.2 TEST SCORES**

Test averages are summarized in table 5.2. For each test, the average scores of the two groups were compared by single factor ANOVA. For the sample, the critical value of F was  $F(\text{crit}) = 3.89$  at  $\alpha = 0.05$ . The scores of the treatment group were significantly higher in March (9.64%) and May (9.5%) with  $F = 23.6$  and  $16.7$  respectively. In February, the difference was small (4.24%) and insignificant with  $F = 2.61$ .

Table 5.2 Comparison of the average test and examination scores for the treatment and control groups. ( $F(\text{crit}) = 3.89$  at  $\alpha = 0.05$ ).

Test	Control group %	Treatment group %	Difference %	F	p
February	43.63	47.87	4.24	2.61	0.107
March	41.73	51.37	9.64	23.06	$3 \times 10^{-6}$
May	42.97	52.47	9.50	16.70	$7 \times 10^{-5}$
June examination (problem section)	25.78	33.58	7.80	13.66	$3 \times 10^{-4}$
June examination (multiple-choice)	30.50	32.71	2.21	0.98	0.323
June examination (total)	27.24	33.31	6.07	9.92	0.002

The treatment group's performance improved from February to March, while the control group's performance deteriorated. At this stage, two possible explanations are considered: the school year started in mid-January, suggesting that the treatment became more effective with time and with regular practise of the problem-solving strategy. It is, therefore, possible that by February, the treatment group had not yet mastered the problem-solving strategy, thus having no advantage over the control group at that stage. By March, it would appear that the treatment group students utilized the strategy to such an extent that they actually were more successful than the control group. Another possible explanation of the trend involves the nature of the subject matter covered by these two tests. The February test dealt with Newton's laws and free falling bodies, for which quantitative problems can be solved successfully using well-known algorithms. On the other hand, the March test dealt with energy and momentum, for which general principles have to be interpreted and applied to the specific problem situation. This is quite different from copying formulae from an information sheet and substituting numbers. It is possible that the treatment group were better equipped to apply such general physical principals for which no ready-made formulas are available on information sheets. This issue will be investigated further

in Chapter 6, which explores the effect of structured problem solving on conceptual understanding.

The results for the June examination showed the treatment group outperforming the control group by 7.8% in the problem section of the paper. In the multiple-choice section, there was little difference between the groups ( $F= 0.98$ ). This was not surprising as the treatment was aimed at solving problems, not choosing answers. Even when including the multiple-choice section, which contributed 30% to the total score, the treatment group showed a significant improvement of 6.07% with  $F=9.92$  over the control group.

The scores were broadly distributed for all tests for both the treatment and the control groups. Standard deviations were typically around 15. The large standard deviation was attributed to many students in both groups who did not have the required background to attempt grade 12 physical science on the higher grade.

The results for separate questions in the June examination are presented in table 5.3.

A pattern appeared when comparing scores on separate questions. For the first three questions, the differences between the groups' scores were small (less than 3%) and insignificant with  $F$ -values below the critical value of  $F(\text{crit}) = 3.89$ . For the last three questions the treatment group scored significantly higher than the control group (more than 10%) with  $F$ -values well above the critical value. Explaining this pattern required taking a closer look at the relevant questions.

Questions 4, 5 and 6 covered topics studied later (March-May) in the grade 12 year. Using the problem-solving strategy seemed to become advantageous as the year progressed, when the volume of work and the likelihood for confusion increased. The topics of questions 4 (momentum and energy) and 5 (electrostatics) were also covered by the March and May tests, with similar favourable results for the treatment group.

Question 1, the multiple-choice section, had both groups performing poorly, with an insignificant difference between the average scores, as mentioned before. This question covered all syllabus topics, suggesting that the enhanced problem-solving skills did not have an effect on the overall

ability to choose correctly from a list of proposed answers. The possibility that second language usage contributed to the poor performance in this question cannot be ruled out.

Both groups performed very poorly in question 2, which dealt with uniformly accelerated motion, a topic studied during the previous year. It seemed that the learners in the treatment group were unable to transfer the problem-solving strategy to a topic studied prior to learning the strategy. The success of the strategy thus appeared to be rooted in its application while learning new content. A final remark on this question: the same topic was included in the pre-test where both groups performed equally poorly. The low scores for this question thus confirmed the pre-test result.

*Table 5.3. Comparison of average scores obtained by the two groups for separate questions in the June examination.*

<b>Question number</b>	<b>Topic</b>	<b>Control group %</b>	<b>Treatment group %</b>	<b>Difference %</b>	<b>F</b>	<b>p</b>
1	Multiple-choice (all topics)	30.50	32.71	2.21	0.32	0.323
2	Constant Acceleration	13.56	16.32	2.74	1.79	0.182
3	Newton's laws	37.67	39.72	2.05	0.46	0.499
4	Momentum and Energy	24.17	37.50	13.33	17.81	$4 \times 10^{-5}$
5	Electrostatics	29.82	40.00	10.187	8.38	0.004
6	Electric Current	28.33	40.00	11.67	10.65	0.001

Both groups did relatively well in question 3, which dealt with Newton's laws, giving an insignificant difference in performance. This result is in agreement with the results of the February test, which also covered Newton's second law. Why would the problem-solving strategy not equip the treatment group to outperform the control group on this particular topic? Most textbooks offer a step-by-step explanation on how to apply the second law: draw a force diagram, resolve the forces into components, substitute the components in the famous second

law equation and solve. Assuming that the control group teachers and students used this typical textbook strategy, the control group would be equipped with a problem-solving strategy for this topic, thereby keeping up with the treatment group. This result was in agreement with Huffman's (1997) conclusion that “textbook” and “explicit” strategies yielded similar results.

### 5.3 PASS RATE

A score of 40% is required for passing the higher grade in South African schools. The pass rates of the two groups were compared and shown in table 5.4. In the pre-test, only 12% of the students from each group passed. The pass rate for both groups increased in the June examination. The treatment group had a pass rate of 36.25% in the problem section, which was almost double that of the control group. In terms of student numbers, the treatment group produced 29 successful candidates compared to 19 from the control group. The inclusion of the multiple-choice section had no effect on the control group's pass rate, but decreased the treatment group's pass rate to 30%. This confirmed that the treatment group were indeed better problem solvers, but had no advantage in choosing correctly.

*Table 5.4. Pass rate in the pre-test and June examination.*

	<b>Control Group</b>			<b>Treatment Group</b>		
	Candidates; passes; pass rate			Candidates; passes; pass rate		
Pre-test	170;	22;	12.08%	179;	22;	12.23%
Examination (problems)	109;	19;	17.43%	80;	29;	36.25%
Examination (total)	109;	19;	17.43%	80;	24;	30.00%

The pre-test profiles of the students who passed the problem section of the June examination were investigated and represented in table 5.5 and figure 5.1. There were clear differences in the composition of the two groups. The majority of successful candidates from the control group were already successful in the pre-test. For the treatment group, the situation is reversed: 58.62% of the candidates, who were successful in June, failed the pre-test, compared to 36.84% of the

control group. This result confirmed that the test group's success in June could not be attributed to initial group differences, but rather to an improvement during the year.

Table 5.5. Pre-test performance of the 48 candidates who passed the problem section of the June examination. The numbers reflect the actual student numbers.

	Control Group	Treatment Group	Total
Failed	7	17	24
Passed	10	10	20
Missed	2	2	4
Total	19	29	48

Figure 5.1. Pre-test profile of all the candidates who passed the problem section in the June examination. The vertical axis represents the percentages of students per group.

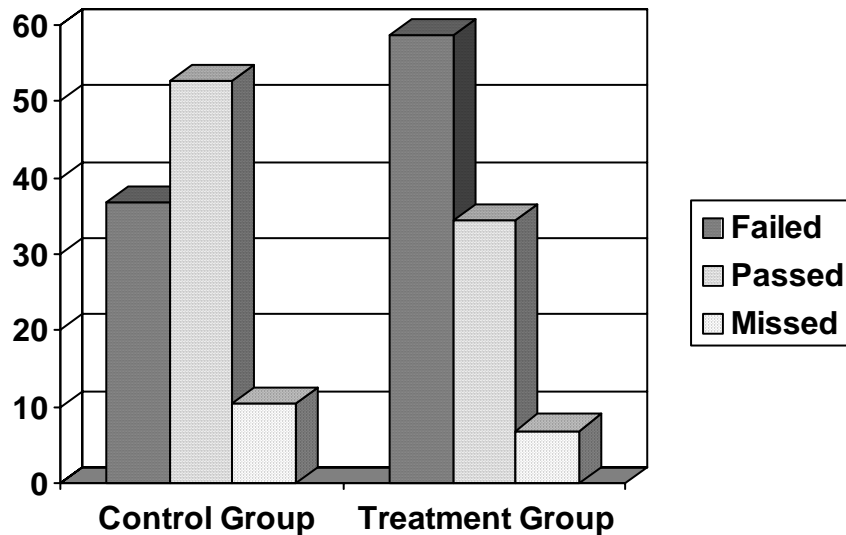

#### 5.4 QUANTITATIVE EVIDENCE OF RELIABILITY AND VALIDITY

Reliability of the instruments was assessed by correlating the June examination results to the test results. These were all set and marked by the researcher. All three tests were taken into account to calculate an average test score for each student. For the June examination, only the problem section was taken into account. Figure 5.2 shows a scatter plot of each student's average test score and June examination score. Correlation coefficients were separately calculated for the treatment and control groups, as well as for the sample. Table 5.6 shows a high degree of correlation, with the value of the correlation coefficient above 0.7 in all three cases. This confirmed that the test results were well reproduced in the June examination, suggesting reliability of instruments.

*Figure 5.2 Scatter plot to relate the scores for the average of the 3 post-tests and the June examination.*

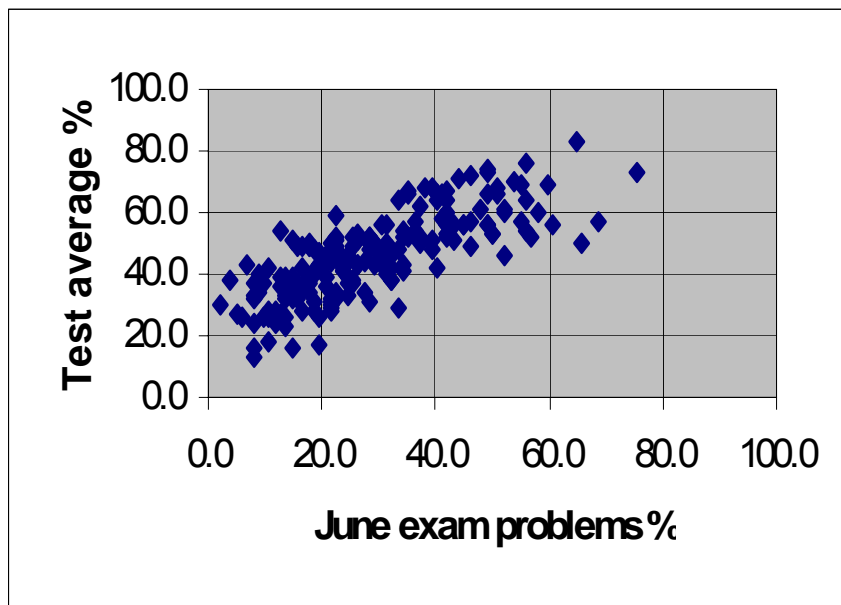

Was the June examination a valid measurement of scores on typical examination problems? The September examination was used as an external standard, as this paper was set by the provincial

education department and marked by the teachers according to the departmental memorandum. To assess the validity of the test instruments, the June examination results were correlated to the September results. Figure 5.3 shows a positive correlation and table 5.6 shows correlation coefficients exceeding 0.8 for each group separately as well as for the sample. This high degree of correlation indicated that the June examination complied with the standard set by the education department for the province.

Table 5.6. Correlation coefficients for scores for the average of the 3 post-tests and the June examination as well as for the June and September examinations.

Tests and Examinations	Control Group	Treatment Group	Sample
Tests – June	0.734	0.785	0.772
June – September	0.838	0.846	0.844

Figure 5.3. Scatter plot to relate September and the June examination scores.

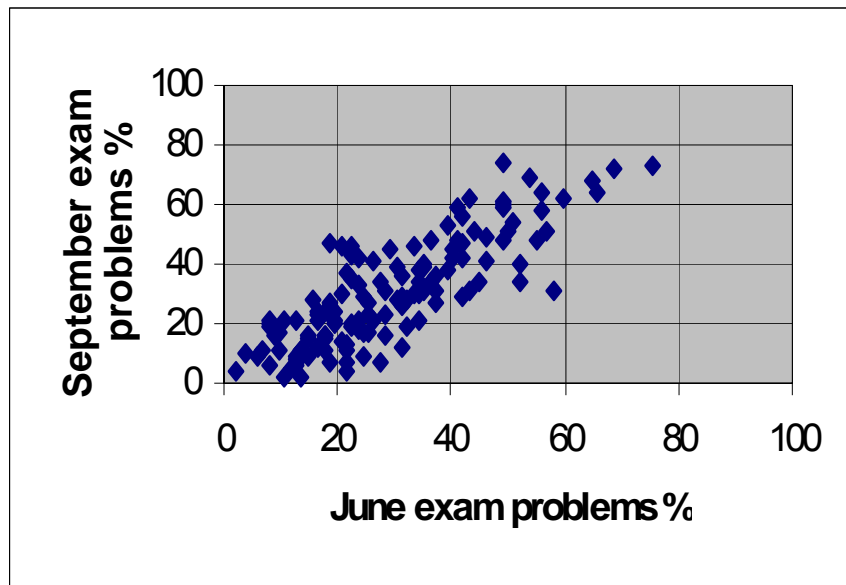



A few schools did not return their September results to the researcher, which reduced the sample of 189 students in June to 145 in September for the purpose of calculating a correlation coefficient. This was not regarded as serious because the smaller sample influenced the June average scores by less than 0.5 %.

## 5.5 INTERACTIONS WITH THE TREATMENT

When comparing average scores obtained by male and female students, it appeared that females benefited more by the treatment. Such a gender effect was reported by Huffman (1997) in a classroom-based study among high school students. Figure 5.4 and table 5.7 indicate that males generally performed better than females, but that the difference was reduced in the treatment group.

Table 5.7. Average scores (%) by gender in the problem section of the June examination.

	Male	Female	Row Average
Control	$\mu_{CM} = 30.84$	$\mu_{CF} = 21.27$	$\mu_C = 26.27$
Treatment	$\mu_{TM} = 35.14$	$\mu_{TF} = 31.73$	$\mu_T = 33.42$
Column Average	$\mu_M = 32.99$	$\mu_F = 26.70$	

The possibility of a gender-treatment interaction was investigated by means of two-factor ANOVA. The treatment and control groups were subdivided according to gender. The ANOVA result, summarized in table 5.8, showed that the interaction null hypothesis could not be rejected at  $\alpha = 0.05$ .

Figure 5.4. Illustration of the insignificant interaction between the treatment and gender. Score refers to the problem section of the June examination.

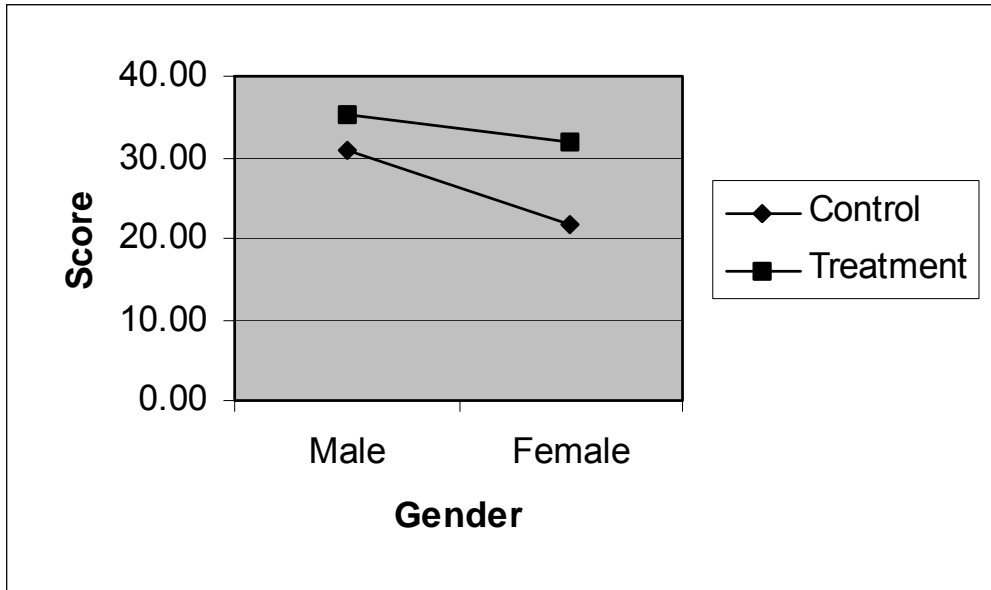

Table 5.8 Two-factor ANOVA table indicating the insignificant interaction between the treatment and gender.

SOURCE	df	MS	F	p	H <sub>0</sub>
Treatment (T)	1	1987.7	9.85	0.002	$\mu_T = \mu_C$
Gender (G)	1	1660.6	8.23	0.005	$\mu_M = \mu_F$
T x G	1	339.2	1.68	0.197	$\mu_{TM} - \mu_{TF} = \mu_{CM} - \mu_{CF}$
Within cells	140	201.6	-	-	-

The possibility that factors other than gender could have interacted with the treatment was also investigated by two-factor ANOVA. These results are summarized in table 5.9. Students were classified as achievers or non-achievers on their pre-test performance; teachers were classified on their qualifications, schools were classified on the school's overall pass rate in the final

departmental examinations of the year 2000 and on their status as public or private schools. In all cases the F-values were well below 1, indicating that no such interactions existed.

Table 5.9 Two-factor ANOVA results showing no interactions with the treatment.

Factor	Levels of factor		F	p
School status	Private	Public	0.161	0.689
School achievement	Above 75%	Below 75%	0.364	0.548
Teacher qualification	Degree	Diploma	0.415	0.521
Student achievement	Passed pre-test	Failed pre-test	0.674	0.413

## 5.6 QUANTITATIVE DESCRIPTION OF CONCEPTUALIZATION

In the June examination, most of the treatment group students did not indicate the steps of the problem-solving strategy in their solutions. In fact, only 21.25% of the treatment group students explicitly indicated steps of the strategy by writing headings for steps in at least one of their solutions. The average score of this subgroup was 40.7% for the problem section of the examination, while the remainder of the treatment group students obtained an average score of only 32.5%. Was this difference significant? Single factor ANOVA showed that this difference was indeed significant with  $p = 0.032$ , suggesting that improved problem-solving performance was associated with those students who explicitly indicated the steps of the strategy.

Was this subgroup that wrote headings the only ones who benefited from the treatment? Why were the headings of the strategy written so seldom in the examination? Was the strategy regarded as of little value, or did it mean that time was a factor? In the questionnaires (Chapter 6) most students complained about the time taken in writing steps, which could have been an obstacle to using the strategy in the examination. Those who wrote the steps for the first problem often did not keep it up throughout the paper, suggesting that they expected that time would run out.

However, the strategy was not intended as a quick fix to apply in tests, but an ongoing process of learning to conceptualize and understand physics while learning to solve problems. Was it possible that using the strategy in the classroom and in homework during the year had an effect on solutions even though headings were not written?

The examination scripts were once again scrutinized for footprints of the strategy. Looking beyond the absence of headings for steps, it was found that the actual steps of the strategy were often visible in solutions, in the form of diagrams and written arguments that *were not explicitly required* by the questions. Diagrams were used by 52.5% of the treatment group in at least one question, and written statements by 32.5%. Could this be regarded as evidence of using the strategy, or should it be regarded as regular practice? To answer this question, the control group's solutions were similarly scrutinized, and it was found that diagrams and writing were less common amongst the control group: only 26.6% of students used diagrams in at least one question, and 13.8% used written statements. This seemed to indicate that using the strategy during the year did promote the use of diagrams and writing during problem solving.

The term “conceptual approach” will be used in further discussions to mean “the use of diagrams or written explanations that were not explicitly required”, while the term “algebraic approach” will be used to refer to solutions which rely only on algebra when diagrams or written explanations were not explicitly required.

Was the treatment group's increased use of a conceptual approach statistically significant? A chi-square analysis was performed, with each student's problem-solving approach classified as either conceptual or algebraic. A student was classified as a conceptual problem solver if he/she used either diagrams or written comments *at least once where it was not explicitly required*. Students who did not meet this requirement were classified as algebraic problem solvers. The contingency table (table 5.10) showed almost two thirds of the treatment group to be conceptual problem solvers, with the situation reversed for the control group.

*Table 5.10. Contingency table showing the differences in the treatment and control group's problem-solving approaches.*

<b>Approach</b>	<b>Treatment group %</b>	<b>Control group %</b>
Conceptual	65.00	33.02
Algebraic	35.00	66.98

The analysis indicated a significant difference in problem-solving approach, with chi-square = 20.46, which is significant at the 0.001 level. The null hypothesis could be rejected; it was thus concluded that the treatment group made significantly more use of a conceptual approach.

The next issue was whether a conceptual approach to problem solving could be linked to a better performance for the entire sample. A chi-square analysis was once again performed, with problem-solving performance measured by the levels “pass” or “fail”. The 40% requirement for passing the higher grade was applied to the scores on the problem section of the June examination. Table 5.11 shows that amongst algebraic problem solvers, failing occurred about ten times more often than passing, while amongst the conceptual problem solvers, passing and failing occurred to more or less the same extent.

*Table 5.11. Contingency table showing problem-solving performance in relation to problem-solving approach for the entire sample.*

	<b>Conceptual %</b>	<b>Algebraic %</b>	<b>Total %</b>
Fail	25.09	46.36	71.45
Pass	23.92	4.63	28.55
Total	49.01	50.99	100.00

Was this difference significant? Analysis yielded chi-square = 38.67, significant with  $p < 0.001$ , calling for rejecting the null hypothesis. It was thus concluded that conceptual problem solvers were more successful across the entire sample.

It was therefore established that:

- Conceptual problem solvers were significantly more successful than algebraic problem solvers.
- The treatment group used a conceptual approach significantly more than the control group.

The conclusion then followed that the treatment group would be significantly more successful than the control group, which was indeed the case, as reported in 5.2 and 5.3.

Could the treatment group's success be attributed to the conceptual approach?

Table 5.12 compares the performances of the two groups in terms of approach. The striking difference between the two groups was that amongst the control group, the largest number of students were unsuccessful algebraic problem solvers, while amongst the treatment group, the largest number of students were successful conceptual problem solvers.

*Table 5.12. Breakdown of student performance in the June examination in terms of approach to problem solving, showing the treatment group, control group as well as the difference between the groups.*

	Conceptual approach			Algebraic approach		
	Treatment %	Control %	Difference	Treatment %	Control %	Difference
Passed	35.00	12.84	22.16	3.75	5.51	-1.76
Failed	30.00	20.18	9.82	31.25	61.47	-30.22
Total	65.00	33.02	31.98	35.00	66.98	-31.98

The difference columns in table 5.12 indicate the difference between the percentages of students from the treatment and control groups following a particular approach. For example, 22.16% more treatment than control group students used a conceptual approach and passed the examination. This suggests that the treatment fostered the development of a conceptual approach, and that the enhanced success of the test group could be ascribed to this change of approach. However, the adoption of a conceptual approach does not guarantee success, as can be inferred from the 30% of test group students who failed despite using a conceptual approach.

It should be emphasized that it is not suggested that algebraic problem solvers cannot be successful. Both the treatment and control groups had a small percentage of successful algebraic problem solvers.

In conclusion, the conceptual approach used frequently by the treatment group is not a rigid, stepwise routine as suggested by the problem-solving strategy. It is an indication that the use of the strategy during the semester shaped the way students thought about physics problems: there was a shift from formulae and numbers to diagrams and written explanations. The diagrams and explanations were indicators and facilitators of mental engagement, conceptualization and interpretation of physics.

## **5.7 CHAPTER SUMMARY**

Eight schools in each group completed the study. The final sample consisted of 80 students in the treatment group and 109 in the control group – excluding students who missed tests.

Average scores of the two groups were compared by single factor ANOVA for each test and the June examination. The treatment group scored significantly higher in tests and examination questions dealing with the topics of momentum, energy, electrostatics and circuits. The differences in scores were insignificant for questions dealing with kinematics and Newton's laws.

The treatment group's pass rate in the June examination was more than doubled when compared to the control group. When looking at improvement on pre-test performance amongst the treatment group, 58% of those who passed in June failed the pre-test. The corresponding figure for the control group was only 37%.

Individual scores in the tests and the June examination showed a high degree of correlation, indicating reliability of the instruments. Validity was confirmed by a high degree of correlation between scores in the June examination and the external departmental examination taken in September.

Two-factor ANOVA showed no significant interaction between the test and student gender, student achievement, teacher training, school achievement and school status.

The steps of the problem-solving strategy were seldom used in students' solutions to examination problems; just more than 20% of the treatment group actually wrote down some of the headings recommended by the strategy. Nevertheless, the influence of the strategy was visible in diagrams and written explanations that were not explicitly required by problems. Students using such diagrams and written explanations were classified as conceptual problem solvers, as opposed to algebraic problem solvers who presented only algebra. Exploring the relationship between the problem-solving approach and success showed a marked difference between the groups, indicating that the enhanced success of the test group could be associated with the increased use of a conceptual approach.



## CHAPTER 6

### RESULTS: QUALITATIVE

This chapter presents qualitative evidence relating to the second research question: What was the effect of a structured problem-solving strategy on conceptual understanding of physics in disadvantaged South African schools? Three different data sources were utilized, namely the June examination scripts, the video session and the questionnaires.

In the first section, students' solutions to selected questions from the June examination will be discussed in detail to explain the treatment groups' enhanced scores in terms of enhanced conceptual understanding reflected by their solutions.

The videotaped session will be discussed next. Case studies will be presented to illuminate the process of applying the problem-solving strategy.

The third section will present results from questionnaires: opinions will be presented to reflect students' and teachers' opinions on the problem-solving strategy.

#### 6.1 SOLUTIONS MAPS

Four questions were selected for detailed analysis of student's solutions. The four questions represented problems for which scores of the two groups differed substantially as well as problems for which the scores were similar. For each of these four questions, a solutions map was constructed. These maps were developed as follows. For a particular problem, each student's solution was classified according to the sequence of physics principles, equations, assumptions and substitutions used. The most popular sequences were represented as routes on a flow diagram called a solutions map. For each route, the percentage of students choosing that route was indicated, for the treatment and control group separately. Different trends amongst the solutions of the two groups became visible on the maps. The differences in trends were interpreted in terms of enhanced conceptual understanding amongst the treatment group.

### 6.1.1 Work and energy

The difference between the scores of the two groups was most prominent in questions on work and energy, in the March test as well as in the June examination. A problem on work and energy was thus chosen for thorough analysis of the students' solutions to establish how the treatment influenced the nature of the solutions. It was argued that this topic could reveal how the solutions of the two groups differed. In the June examination, the problem on energy and work consisted of two parts, (a) on energy conservation and (b) on the work-energy principle. The problem is given below, followed by separate analysis of students' solutions to the two subdivisions.

#### June examination, question 4.2

A car with a mass of 200 kg starts at A and rolls down a track as shown in the diagram. It reaches B with a speed of 12 m/s.

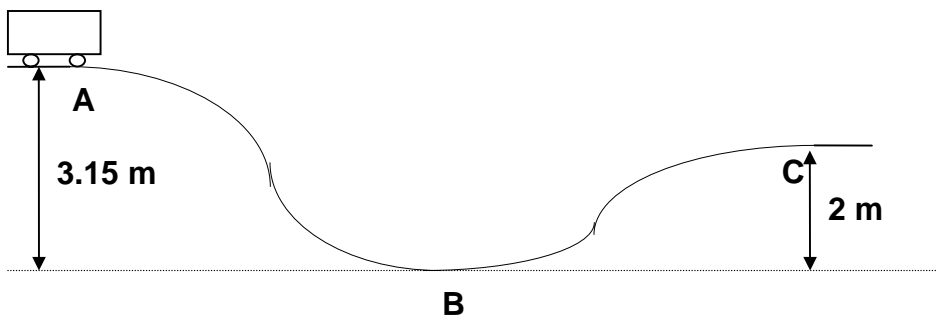

- Calculate the speed with which the car started at A. Assume there is **no friction** between A and B.
- The track between B and C is **rough**. The car does work of 2300 J against friction while moving from B to C. Calculate the speed of the car when it reaches C.

*Solution*

- From A to B, mechanical energy is conserved:

$$E_P + E_K = \text{constant}$$

$$mgh_A + \frac{1}{2}mv_A^2 = mgh_B + \frac{1}{2}mv_B^2$$

$$gh_A + \frac{1}{2}v_A^2 = gh_B + \frac{1}{2}v_B^2$$

$$10 \times 3.15 + \frac{1}{2}v_A^2 = 0 + \frac{1}{2} \times 12^2$$

$$v_A^2 = 81$$

$$v_A = 9 \text{ m/s}$$

*This is the speed with which the car started at A.*

- b. *From B to C, mechanical energy changes, work done on the car equals the energy change:*

$$W = E_C - E_B$$

$$W = (mgh_C + \frac{1}{2}mv_C^2) - (mgh_B + \frac{1}{2}mv_B^2)$$

*Friction causes an energy loss, meaning a negative amount of work is done on the car:*

$$-2300 = (200 \times 10 \times 2 + \frac{1}{2} \times 200 \times v_C^2) - (0 + \frac{1}{2} \times 200 \times 12^2)$$

$$v_C^2 = 81$$

$$v_C = 9 \text{ m/s}$$

*The speed of the car is 9 m/s when it reaches C.*

*The solutions presented by the students to the problem given above are discussed separately for the two parts.*

**a. Conservation of mechanical energy**

Question 4.2a, dealing with energy conservation, involves a car given an initial speed when travelling downhill. The initial speed makes the problem more difficult than the simplest energy conservation problems that typically deal with objects starting from rest, moving down ramps or swinging from strings without friction. Students usually have to calculate the speed at the lowest point, or the maximum height reached. In such simple cases the energy conservation law boils down to a simple relation between maximum speed and maximum height:

$$\frac{1}{2}mv^2 = mgh$$

Students, and perhaps teachers, may use this equation without emphasizing or realizing that v and h actually refer to the extremes of the path. Even when a student uses this equation correctly,

it is no guarantee that he/she understands that the conservation principle refers to the *sum* of the kinetic and potential energy at *any* position along the path. In order to assess deeper understanding, problems can be formulated to include more than just a maximum speed and a maximum height. In such problems, the conservation of mechanical energy can be written to refer to any two points along the path:

$$\frac{1}{2}mv_1^2 + mgh_1 = \frac{1}{2}mv_2^2 + mgh_2.$$

In the June examination, an initial speed at a given height was included to rule out the use of the simple formula. The students had to determine the initial speed of a car moving downhill without friction. In this case, energy conservation can be expressed as:

$$\frac{1}{2}mu^2 + mgh = \frac{1}{2}mv^2$$

Here  $u$  and  $v$  respectively represent the initial and final speed while  $h$  represents the initial height.

Each student's solution was analysed and classified according to his/her approach. The approaches, labelled routes i to vii, are represented on a solutions map, figure 6.1. Solutions were broadly classified into 2 main groups, depending on whether or not the student made some use of energy concepts. Amongst the treatment group, 72.5% of the students compared to 50.3% of the control group approached the problem by using energy concepts.

Amongst the solutions referring to energy, routes i, ii and iii explicitly mentioned that the sum of kinetic and potential energy remained constant. Grouped together, these solutions added up to 41.3% of the treatment group and only 11.1% of the control group. Route i represented the correct substitutions, leading to the correct answer of  $9 \text{ m}\cdot\text{s}^{-1}$ . Despite a low success rate of 23.8% for the treatment group, it was more than double that of the control group.

The incorrect answer obtained by most students from both groups was  $7.9 \text{ m}\cdot\text{s}^{-1}$ . This answer resulted when calculating the *final* speed of a car starting from *rest* at the given height, instead of

Figure 6.1. Breakdown of students' solutions to the energy conservation problem. Route i represents the correct solution. Percentages of treatment group students following particular routes are indicated, percentages in brackets refer to the control group.

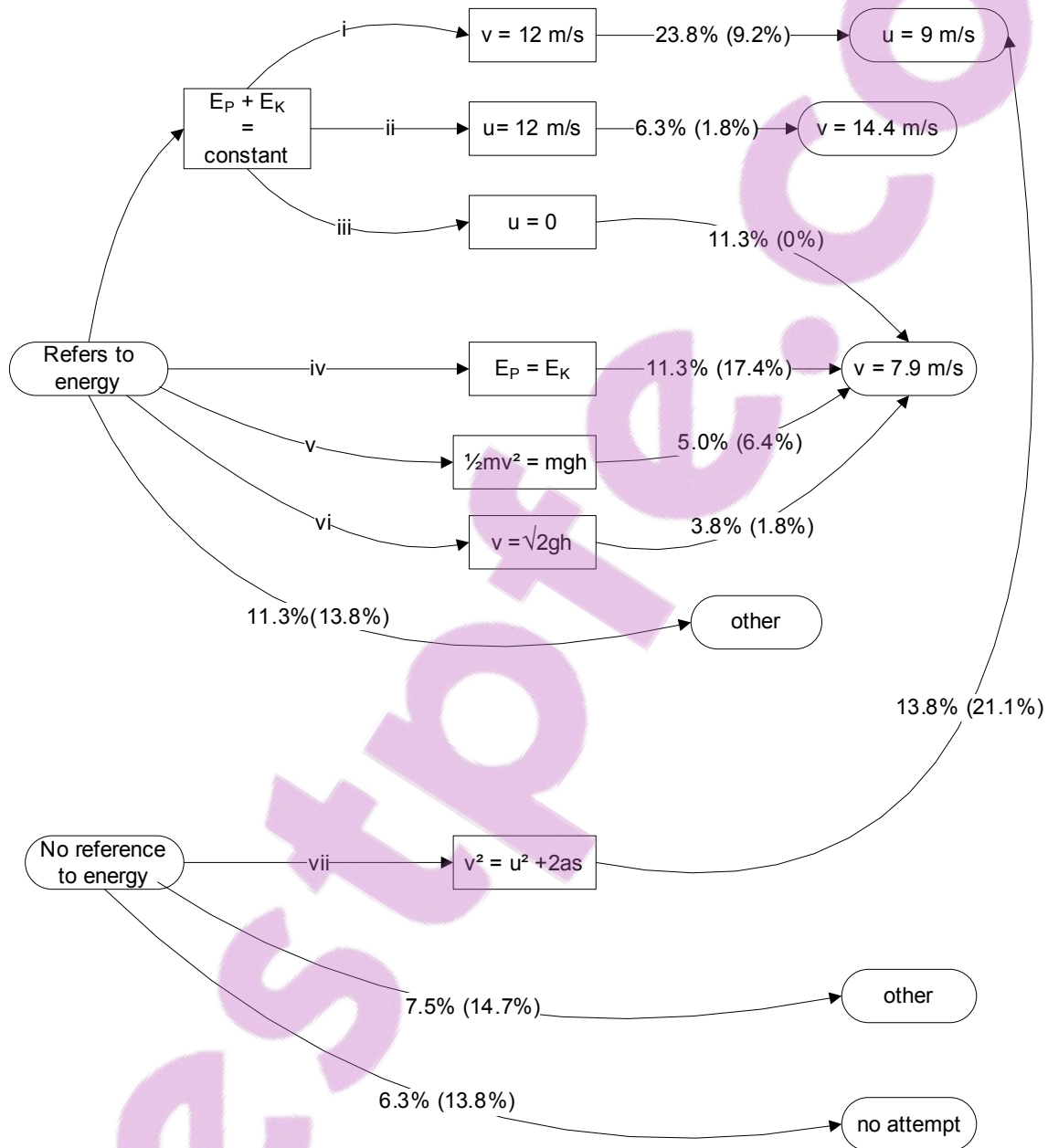

calculating the *initial* speed of a car that reaches the *given final* speed. The solutions, represented by routes iv to vi, all used variations of kinetic energy = potential energy, which was equivalent to the simple relationship between maximum height and maximum speed. Students following these routes ignored the given final speed and calculated a final speed for a car starting from rest. It seemed that they merely checked for symbols (height and speed) to choose a formula. Neither the conservation principle nor the question was understood.

Route iii represented a correct start by making provision for an initial speed but then substituting it for zero, thus joining routes iv, v and vi. This approach was followed by 11.3% of the treatment group but none of the control group students, suggesting that these students learnt to start with a better formula, without a corresponding level of conceptual understanding. Although somewhat paradoxical, this approach seemed to confirm that the strategy was employed, though not with success in this case. Despite being able to write an appropriate relation to include an initial velocity, the students were unable to substitute the data, suggesting a lack of comprehension.

Another common mistake, represented by route vii, was to use  $v^2 = u^2 + 2as$ , a well-known equation of motion for constant acceleration. Using this equation was inappropriate because the motion was nonlinear. Students following this route substituted the given vertical height for  $s$ , the gravitational acceleration for  $a$ , and arrived at a numerically correct answer of  $9 \text{ m.s}^{-1}$ . Although the equation might look like an energy conservation equation for which the mass was cancelled out, it was not accepted as correct because the students made no mention of energy. Amongst the control group, 21.1% of solutions followed this approach, compared to only 13.8% of the treatment group.

Students following route ii interchanged the given final speed of 12 m/s with the required initial speed, reflecting a tendency to regard the beginning as known and the end as unknown. This occurred more amongst the treatment group (6.8%) than amongst the control group (1.8%). However, these students showed an awareness of the fact that mechanical energy involves kinetic *and* potential energy, rather than kinetic *or* potential energy.

## b. The work-energy principle

Question 4.2b described the car travelling uphill while doing work against friction, following the frictionless, downhill motion of part a. This is more complicated than the simplest work-energy problems that deal with frictionless systems where objects are either pushed horizontally, starting from rest, or lifted vertically at constant speed. In these simple cases, the work-energy relation involves nothing more than the definitions of kinetic and potential energy:

$$W = \frac{1}{2}mv^2 \quad \text{and} \quad W = mgh$$

For such simple cases, students can arrive at correct answers without understanding the concept of work as energy being transferred, with a possible change in both kinetic and potential energy at the same time. In order to assess deeper understanding of the principle, more complicated problems should be given, for which the work-energy relation can be written as:

$$W = (\frac{1}{2}mv_2^2 + mgh_2) - (\frac{1}{2}mv_1^2 + mgh_1).$$

In part b of question 4.2, the students had to calculate the speed of the car when it reached a specified height. Each student's solution was classified according to his/her approach. The different types of solutions are represented by routes i to vii on the solutions map, figure 6.2. The solutions were broadly classified into two categories, namely those that indicated that doing work effects a *change* in energy and those that did not indicate a *change* in energy.

Both groups did poorly in this question: Only 25.1% of the treatment group compared to 8.3% of the control group referred to work as a *change* in energy. However, the percentage for the treatment group was 3 times more than that of the control group, indicating better conceptual understanding.

Route i represents the correct solution, where friction is treated as a negative amount of work done on the car, reducing the speed to  $9 \text{ m}\cdot\text{s}^{-1}$ . Students from both groups seemed to have difficulties, with only 5% of the treatment group and 3.7% of the control group getting it right.

Figure 6.2. Breakdown of students' solutions to the work-energy problem. Route i represents the correct solution. Percentages of treatment group students following particular routes are indicated. Percentages in brackets refer to the control group.

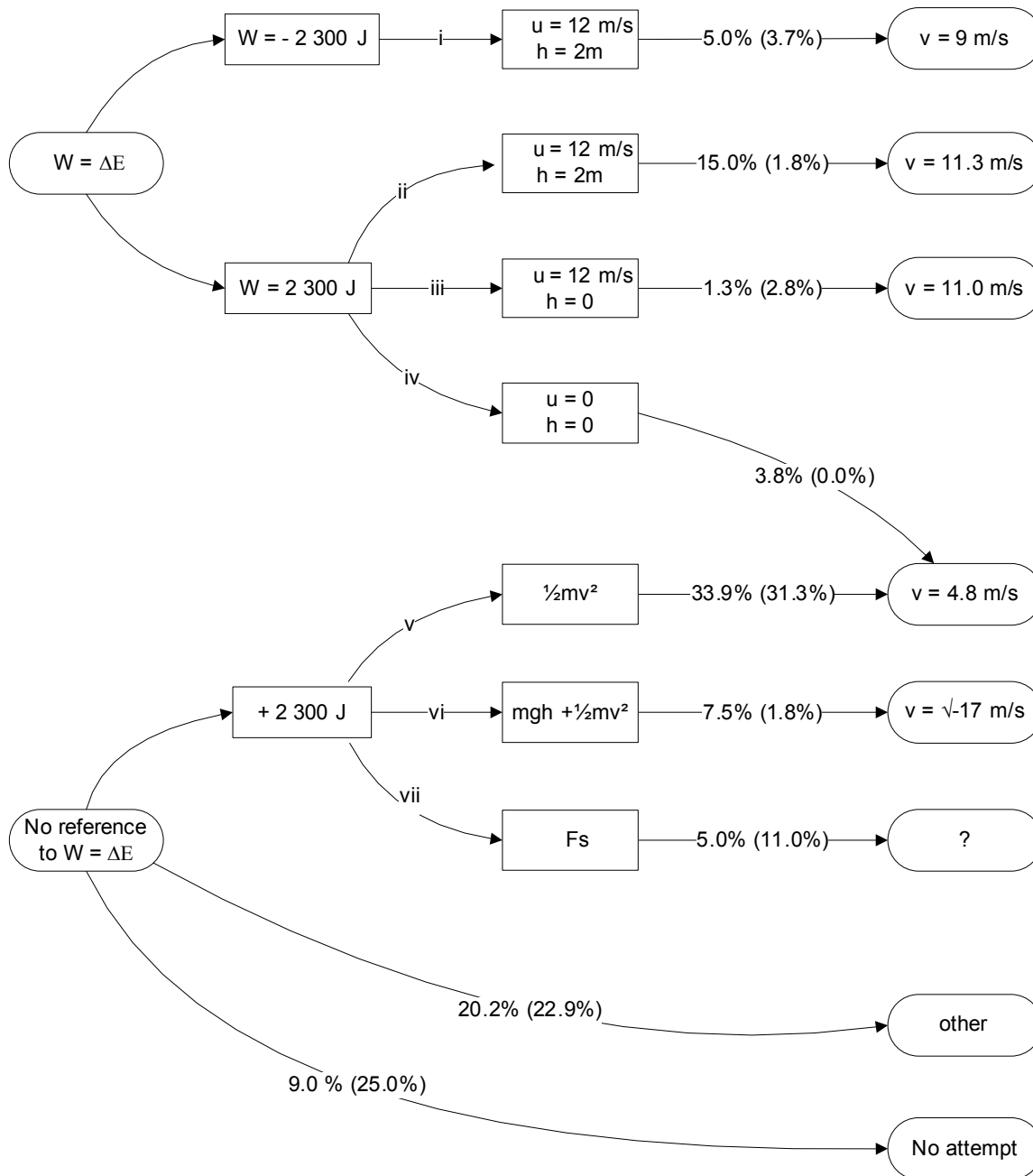



In all other solutions, represented by routes ii to vii, the students equated work done against friction as a positive amount, with various different mistakes following. More than 66% of the treatment group and 48% of the control group fell in this category. Clearly, work done against friction was a vague concept for both groups, even if they might be familiar with the concept of energy lost due to friction.

Route ii represents a common solution amongst the treatment group. Apart from having positive work done *on* the car, the students solved the problem correctly in all other respects, taking into account the changes in both kinetic and potential energy. Despite being unable to model work done *against* friction, these students showed understanding of the fact that work done on an object can simultaneously change both kinetic and potential energy. 15% of the treatment group followed this approach, compared to less than 2% amongst the control group, suggesting enhanced, though not complete, conceptual understanding amongst the treatment group.

A small group of students from both groups equated work done on the car as an increase in kinetic energy only. These attempts are represented by route iii.

The most common approach amongst both groups is represented by route v. The kinetic energy definition was used, with the work done against friction equated as kinetic energy, thereby ignoring the initial speed, the height increase as well as regarding friction to increase kinetic energy. About one third of each group proceeded this way, showing very limited conceptual understanding of the work-energy relation amongst both groups.

Routes iv and v effectively had positive work done on a car starting from rest on a horizontal plane. Route iv represented a small number of the treatment group who started correctly with the work-energy principle, but then substituted zero for both initial speed and height, ending as route v. Once again this seems to suggest the use of the problem-solving strategy without conceptual understanding.

Route vi had work done equal to kinetic plus potential energy, arriving at the square root of a negative number. These students ignored the minus and obtained a positive final speed. Although

showing awareness of the fact that both kinetic and potential energy was involved, these students not only ignored the initial speed, but also showed poor mathematical insight.

Amongst the control group, a popular point of departure was by defining work as force  $\times$  distance, represented by route vii. This approach was a dead end for this problem, showing no connection between work and energy.

Did the treatment group show enhanced conceptual understanding in this question? The answer still seemed to be yes despite the poor modelling of friction. When looking at routes i and ii together, the treatment group demonstrated better conceptual understanding of work as a *change* in mechanical energy.

### 6.1.2 Kinematics

The problem on kinematics (question 2.1) was very poorly answered by both groups, and the average scores for this question differed by only 2.8%. This question was chosen for analysing solutions to investigate why the strategy did not produce improved performance amongst the treatment group. The problem and solution is given below:

#### June examination, question 2.1

*A minibus travels at a constant speed of 32 m/s on a straight road. The driver sees a stationary truck 130 m down the road. The reaction time of the driver is 0.2 s. The driver then applies the brakes, decreasing his speed uniformly at 4 m/s<sup>2</sup>.*

*Does the minibus come to rest before reaching the truck? Do a suitable calculation to support your answer.*

#### Solution

*During the reaction time, the velocity is constant:*

$$s = vt = 32 \times 0.2 = 6.4 \text{ m}$$

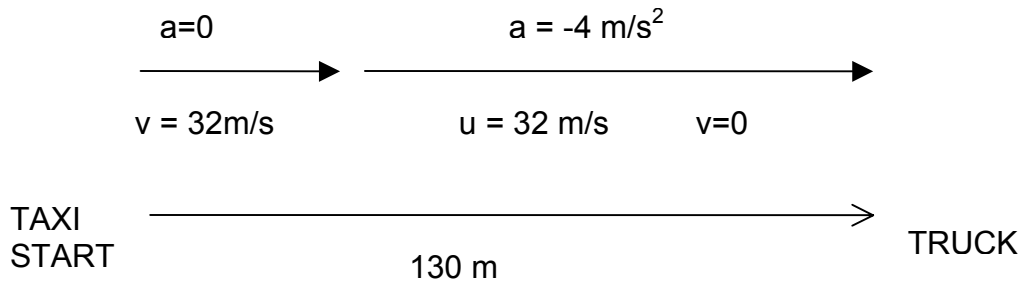

To stop while decelerating at  $4 \text{ m/s}^2$ :

$$v^2 = u^2 + 2as$$

$$0 = (32)^2 + 2(-4)s$$

$$8s = 1024$$

$$s = 128 \text{ m}$$

Total stopping distance required:  $6.4 + 128 = 134.4 \text{ m}$ .

Therefore the minibus will not be able to stop in time, since the truck is 130 m away.

*Note: This is not the only way to show that 130 m is not enough to stop in time! One can also calculate the required deceleration in order to stop after exactly 130 m, or calculate the velocity of the minibus when it has travelled 130m.*

Question 2.1 involved two different parts, namely a constant velocity part during the driver's reaction time, and a uniform acceleration part while the brakes are applied. This problem was, therefore, more complicated than the typical cases of uniform acceleration throughout the motion, when three well known equations relate displacement, velocity, acceleration, time and initial velocity as follows:

$$v = u + at$$

$$s = ut + \frac{1}{2}at^2$$

$$v^2 = u^2 + 2as$$

The displacement is measured relative to the position of the object when the clock is started. The symbols have the following meanings:

$t$  = time

$a$  = acceleration

$v$  = velocity at time  $t$

$u$  = initial velocity

$s$  = displacement at time  $t$

These equations are usually supplied on an information page, the reason being that students need not memorize equations, but that they should be able to use them.

The simplest applications of the three equations can hardly qualify as problems. Students use data to make lists matching symbols with numbers, choose a formula which contains the data symbols and the symbol representing the answer, substitute the numbers and solve the problems algebraically. In fact, the problems can be so easy that the meaning of the equations and the process of problem solving can go unnoticed, thereby actually inhibiting conceptual development.

Problems become more difficult when matching data with symbols requires some interpretation. For example, when there are two objects, there can be two variables that match the same symbol. When one object undergoes two consecutive motions, more than one equation may be required, with one variable linking equations. It becomes essential to understand the meanings of symbols and the ranges in which they are valid. Linked variables are represented by different symbols, depending on which part of the problem is addressed. It is in fact not likely to solve these types of problems without a clear conceptual understanding of the link and the relevant physics principles.

Question 2.1 given in the June examination assessed whether students were able to recognize that the equations for constant acceleration were not applicable throughout the motion: a driver sees a stationary vehicle ahead, he does not react immediately, but then applies the brakes in an effort to avoid a collision. It is a typical textbook problem involving two related parts. However, the question was not *presented* in two parts. Instead, the students had to realize by themselves that the motion with constant velocity during the reaction time required a separate calculation. Furthermore, the students had to decide for themselves what should be calculated to know

whether a collision could be avoided. The initial speed, the initial distance to the other vehicle, the deceleration and the reaction time were all given quantities. Should symbol matching be attempted, nonsensical answers would result, because the given variables  $t$ ,  $s$  and  $a$  do not refer to the same part of the motion.

Both groups performed very poorly on this question. No striking difference in percentages of students from the two groups could be detected in any of the solution routes shown in figure 6.3. Only four students followed the correct route; three from the control group, and one from the treatment group.

The solutions were broadly classified into two main groups. The first group represented the motion as a succession of two different models, while the second group used only one model.

Students using two-model solutions represented the motion as an initial part with constant velocity during the reaction time, followed by uniformly accelerated/decelerated motion while the driver applied the brakes. For the correct solution, route i on the solutions map, the car is shown to travel 6.4 m during the reaction time, and is then shown to require another 128 m to stop while decelerating. The total stopping distance of 134.4 m thus exceeds the specified initial distance of 130 m between the vehicles. A collision is thus inevitable (if the driver keeps going in a straight line). Only four students had this correct, each used a diagram, distinguishing clearly between the two successive parts of the motion. Three other students modelled the motion during the reaction time correctly, but they could not do the part where the car decelerated. These solutions, labelled as route ii, showed an awareness of the limitations on the applicability of the constant acceleration equations, although they could not model stopping.

The second main group of solutions completely ignored the constant-velocity-part of the motion. The students employed only one model, namely constant acceleration/deceleration throughout. These solutions naturally fell into two levels of understanding, namely those who correctly represented stopping as a negative acceleration (routes iii-vi), and those who showed no insight by actually substituting positive values for the acceleration (routes vii-x).

Figure 6.3. Breakdown of students' solutions to the kinematics problem. Route i represents the correct solution. Percentages of treatment group students following particular routes are indicated. Percentages in brackets refer to the control group.

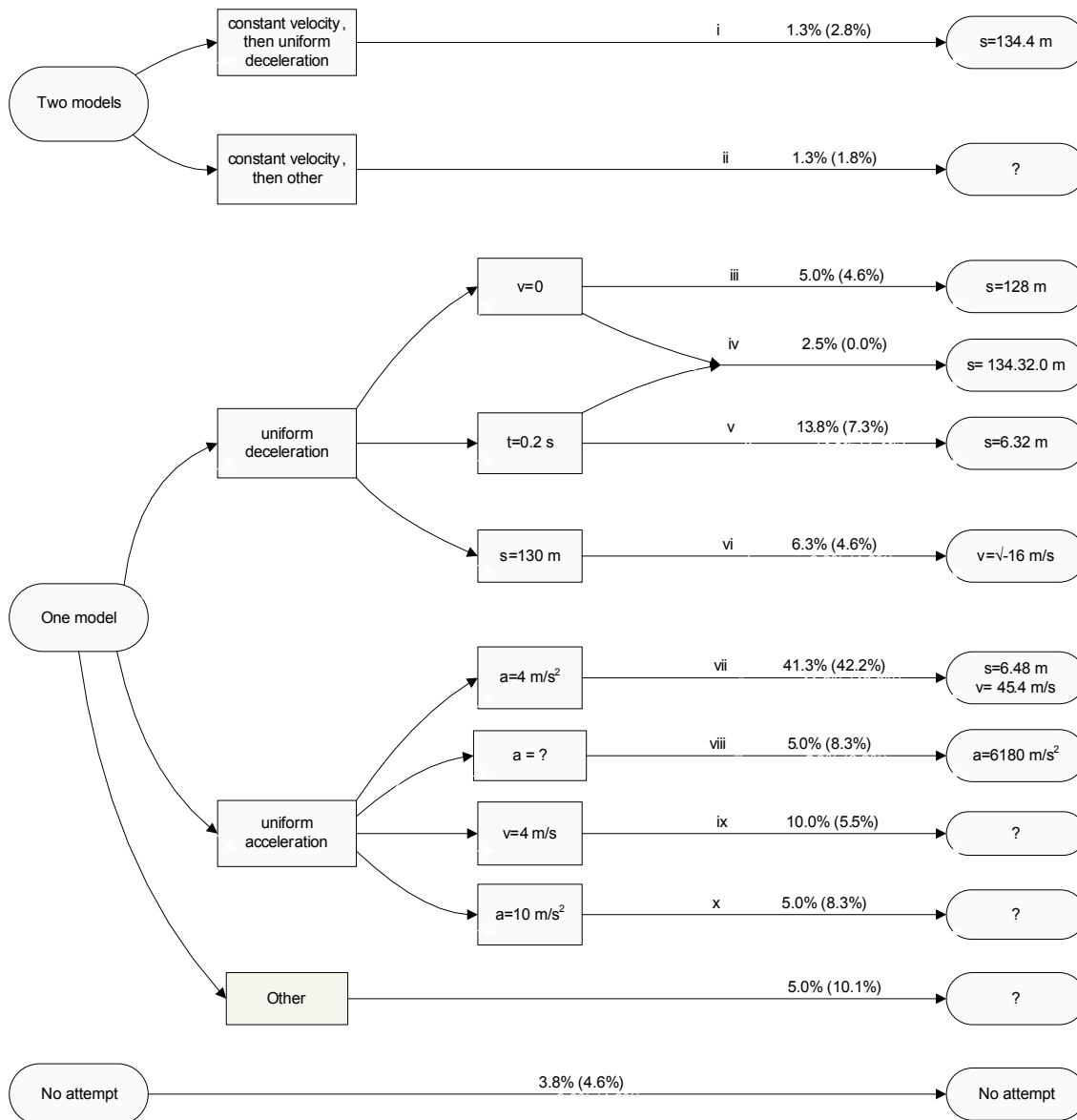

Despite ignoring the uniform motion during the reaction time, the solutions iii-vi showed insight into modelling slowing down as a negative acceleration, or deceleration as used in some texts. Route iii was simply the calculation of a stopping distance as if there were no reaction time. Route iv had the motion divided into two parts, but the acceleration of  $-4 \text{ m/s}^2$  was also applied during the reaction time. These students clearly realized that there were two different parts of the motion, but they failed to model the difference. In route v, the entire motion was assumed to occur during the reaction time; it can be argued that this mistake was a language problem. Route vi represented the least insight amongst this group who used negative accelerations. These students assumed that the car covered the entire 130 m while decelerating, which led to a final velocity of  $\sqrt{-16} \text{ m/s}$ . In some cases, this was interpreted as 4 m/s, moving backwards.

The majority of the students, more than 60% of each group, used one model, with a *positive* acceleration to represent a car coming to rest. This group of solutions was indicative of matching numbers with symbols, showing little insight. These solutions represented very poorly developed conceptual understanding of the vector nature of acceleration.

What can be concluded from a problem that was so poorly answered? Why did the problem-solving strategy produce so little effect in this question? Recall that the physics syllabus for the Grade 12 final examination in South Africa is taught over two years, starting in grade 11. The section on kinematics is scheduled to be taught in the grade 11 year throughout the country. It was thus covered and examined in the year prior to this investigation, and was also used as a pre-test topic. Both groups were supposedly familiar with the content. However, the treatment group only learnt the strategy in the grade 12 year, after completing the kinematics in grade 11. It thus appears that students were unable to transfer the problem-solving strategy to a topic studied prior to learning the strategy. Such lack of transfer, together with the poor conceptual understanding demonstrated in this question emphasized that the strategy was inefficient when not supported by conceptual understanding. This in turn suggested that applying the strategy while learning new content assists the development of conceptual understanding of that content.

Note that it cannot be concluded that the treatment group's solutions would have been better or different if students had learnt the problem-solving strategy earlier, before studying kinematics. It remains undecided whether the poor performance of the treatment group was caused by an inability to transfer the strategy to previously learnt content, or whether it was an inability to distinguish between two separate models that are both present in one solution. It is not certain that students would have been able to construct a solution from two different types of motion involving different relations, even if they learnt this content (kinematics) while using the strategy. It would, therefore, be useful to analyze another problem where a solution had to be constructed from parts involving different models. In the kinematics problem, the two models were both from kinematics, namely motion with constant velocity and uniformly accelerated motion. The next question chosen for analysis involves two models from different domains of science, namely mechanics and electrostatics.

### 6.1.3 Electrostatics

The electrostatics problem given in the June examination could shed light on an outstanding issue from the previous problem: did the treatment group develop enhanced skills to solve problems involving different physics models? In the next problem, mechanical as well as electrical concepts were involved; the solution thus required a synthesis of concepts from two different domains of physics. The problem is given below:

#### June examination, question 5.2

*A charged polystyrene ball A lies at the bottom of a glass cylinder. An identically charged ball B is dropped into the cylinder. B is repelled by A and it comes to rest above A such that the distance between the centres of the balls is 9 cm.*

*The mass of each ball is 10 g.*

*Calculate the charge on each ball.*

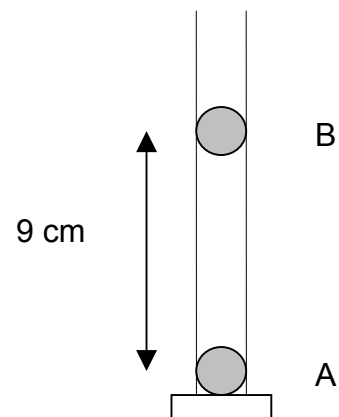



*Solution*

*Ball B is in equilibrium, meaning the forces on ball B are balanced.*

$$\text{Downward force} = mg$$

$$\text{Upward force} = kQ^2/r^2$$

$$kQ^2/r^2 = mg$$

$$9 \times 10^9 \times Q^2 = (10 \times 10^{-3}) \times 10$$

$$Q^2 = 9 \times 10^{-14}$$

$$Q = \pm 3 \times 10^{-7} \text{ C.}$$

Electrostatic force

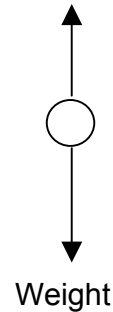

*Since the balls repel one another, the charges could be both positive, or both negative.*

This was an equilibrium problem where the weight of an object was balanced by an electrostatic force. Although it resembled Millikan's oil drop experiment, there was a fundamental difference: while a constant field was used in the Millikan experiment, here the electrostatic force was produced by two charged spheres. The standard formula for the charge on Millikan's oil drop would therefore be inappropriate, because the electrostatic force would be governed by Coulomb's law rather than by a uniform field. In order to determine the unknown charge, the students had to apply three relationships, namely the equilibrium condition, the expression for the gravitational force as well as Coulomb's law.

The solutions, mapped in figure 6.4, were classified into two main groups: those who applied more than one physics relationship, as opposed to those who used only one relationship. For clarity: when only one equation was applied in standard form (using the information sheet or memory), the solution would be regarded as a single relationship solution. When more than one equation (or an equation constructed from others) was used, the solution was classified as a multiple relationship solution. Amongst students who used multiple relationships, the majority attempted to balance forces, while some made inappropriate use of the concept of gravitational potential energy.

Figure 6.4. Breakdown of students' solutions to the electrostatics problem. Route i represents the correct solution. Percentages of treatment group students following particular routes are indicated. Percentages in brackets refer to the control group.

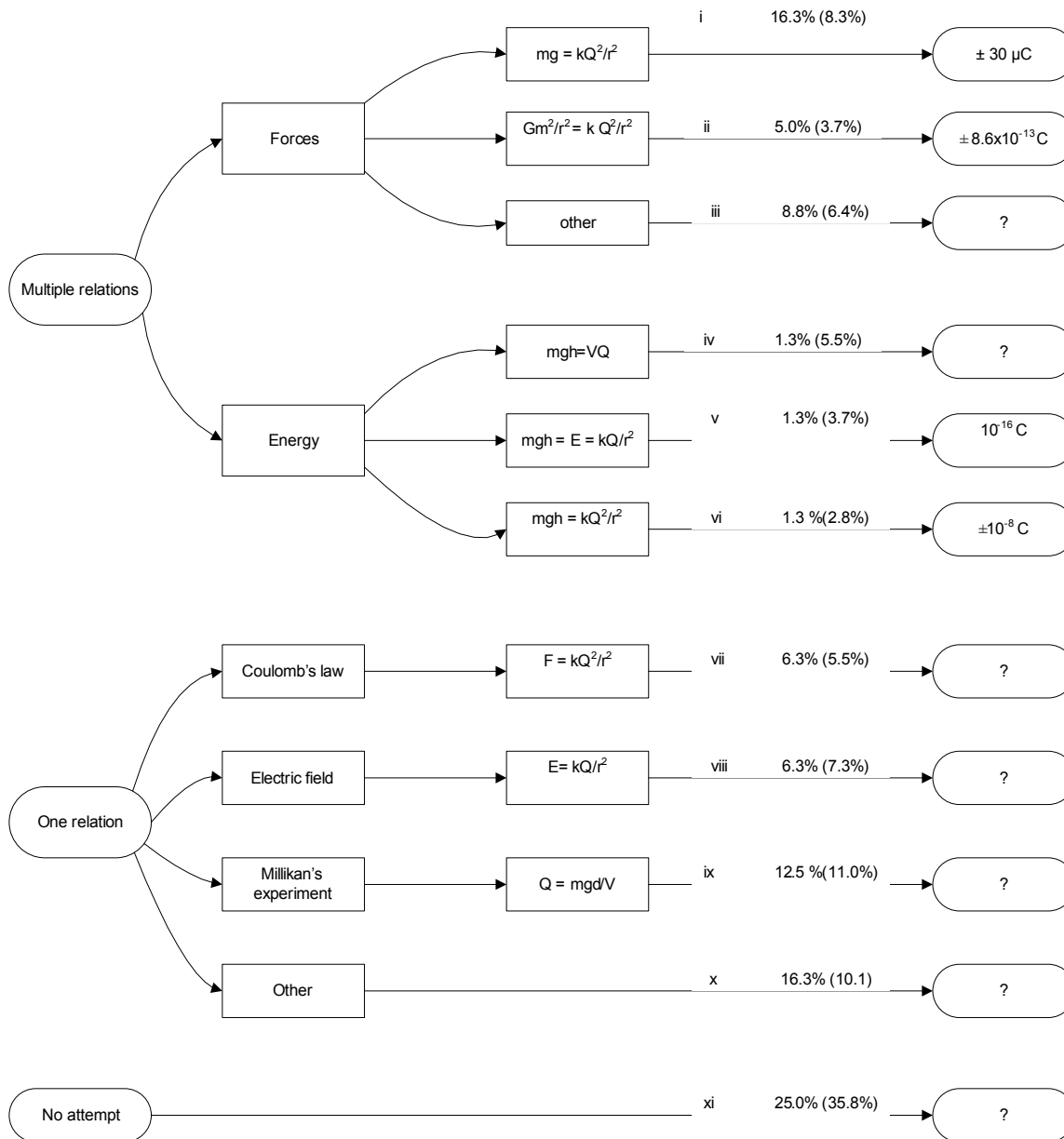

The correct solution, route i, was followed by 16.3% of the treatment group; this represented almost double the control groups' successes. Here the weight of the floating sphere was balanced by the electrostatic repulsion between the two spheres. In route ii, Newton's universal gravitation law was applied by a minority (5% and less in both groups) to consider the force of attraction between the two balls as the only downward force acting on the floating ball. Although this force exists, it is negligible compared to the earth's attraction. Nevertheless, these students recognized that forces from two domains of physics were balanced.

Students who followed routes iv to vi showed an awareness of the fact that two domains of physics were involved, but could not link them correctly. Instead of balancing forces, gravitational potential energy was equated to electrical concepts. In route iv, electrical potential energy was involved, although the potential difference was unknown. (In South African high schools, potential difference calculations are restricted to uniform fields). In route v, the electric field strength  $E$  was confused with potential energy, clearly an indication of a tendency to remember symbols instead of understanding concepts.

The solutions vii to x, involving only one relation, were generally very poor. Most significant here, was the misapplication of the formula for Millikans' experiment. Clearly the students using this equation had a poor conceptual understanding of situations to which the equation applied. Slightly more than 10% of each group followed this route; this reflects a tendency of students to remember a formula, and apply it without questioning its relevance.

In route vii, Coulomb's law was written down, but inappropriate values were substituted for the value of the electrostatic force. Route viii applied the expression for the electric field of a point charge, and often the charge of an electron ( $e$ ) was substituted for the electric field strength ( $E$ ). Once again, this indicated a tendency to match symbols to data, at a very low level of conceptual understanding

Large percentages of students from both groups did not even try to solve this problem: 25% of the treatment group and almost 36% of the control group did not offer any attempt. It is not uncommon for students to avoid the later questions in examinations, for various possible reasons:

they may have been struggling to finish the examination paper in time, while studying, they may have given up before reaching the last chapters, or the teacher may have been struggling to finish the syllabus in time before the examinations. Whatever the causes may be, failure to attempt this question was reduced amongst the treatment group.

The analysis of the solutions to this question indicated that the treatment group students were in fact better equipped to construct a solution that involved multiple relationships from different domains of physics. Such synthesis from different domains of physics indicated enhanced conceptual understanding amongst the treatment group. It can then be assumed that the treatment group's poor performance in the kinematics problem was caused by an inability to transfer, not by difficulties to apply multiple relations. Furthermore, this question also showed that more treatment group students were enabled to complete the examination paper.

#### **6.1.4 Solutions maps interpreted in terms of a conceptual approach**

How did the solutions maps relate to the notion of conceptual and algebraic approaches, discussed in 5.6? The conceptual/algebraic classification of students was now utilized to define an index by which the popularity of routes amongst conceptual problem solvers could be assessed. The conceptual index (C-index) for a route was defined as the number of conceptual problem solvers who followed that route, divided by the total number of students who followed that route.

The energy conservation problem (4.2a) and the electrostatics problem (5.2) were considered instructive examples to investigate whether the conceptual and algebraic approaches were similarly represented in different routes. For each of these problems, the correct route as well as a popular formula-based route was investigated. The formula-based routes were route vii in fig. 6.1 and route ix in fig. 6.4. For the energy conservation problem, route vii was based on the inappropriate use of the constant acceleration formula  $v^2 = u^2 + 2as$ , while for the electrostatics problem, route ix made inappropriate use of the formula  $Q = mgd/V$  for charge in Millikan's experiment.

Table 6.1 summarizes the C-indexes for these problems and routes, separately calculated for the two groups. Also shown are the C-indexes of both groups for the entire June examination paper that serves as baseline for comparison. These baselines refer to the 65% of the treatment group and 33% of the control group students that were classified as conceptual problem solvers in section 5.6.

*Table 6.1 Comparison of conceptual indexes for the treatment and control groups for selected examples from the June examination, as well as for the entire paper. The route labels refer to the solutions maps in figures 6.1 and 6.4.*

Question	Solution Route	Treatment group		Control group	
		% of students	C- index	% of students	C-index
Energy conservation	(i) correct	23.8	0.895	9.2	0.600
	(vii) formula-based	13.8	0.455	21.1	0.391
Electrostatics	(i) correct	16.3	0.769	8.3	0.444
	(ix) formula-based	12.5	0.500	11.0	0.250
All questions		100	0.650	100	0.333

For the energy conservation question, route i, representing the correct solution, had large C-indexes for both groups. For the treatment group, 89.5% of those who followed the correct route were conceptual problem solvers, well above the 65% baseline. The corresponding value was 60.0% in the control group, well above the 33% baseline for the control group. Figure 6.5a clearly shows that the C-index for the correct solution (route i) exceeds the baseline for each group. With respect to the inappropriate formula-based solution (route vii), only 45.5% of the treatment group were conceptual problem solvers, below the 65% baseline. In the control group the 39.1% were conceptual problem solvers, slightly above the 33% baseline.

Figure 6.5a. Comparison of the C-index for the correct solution and an inappropriate formula-based solution to the energy conservation problem.

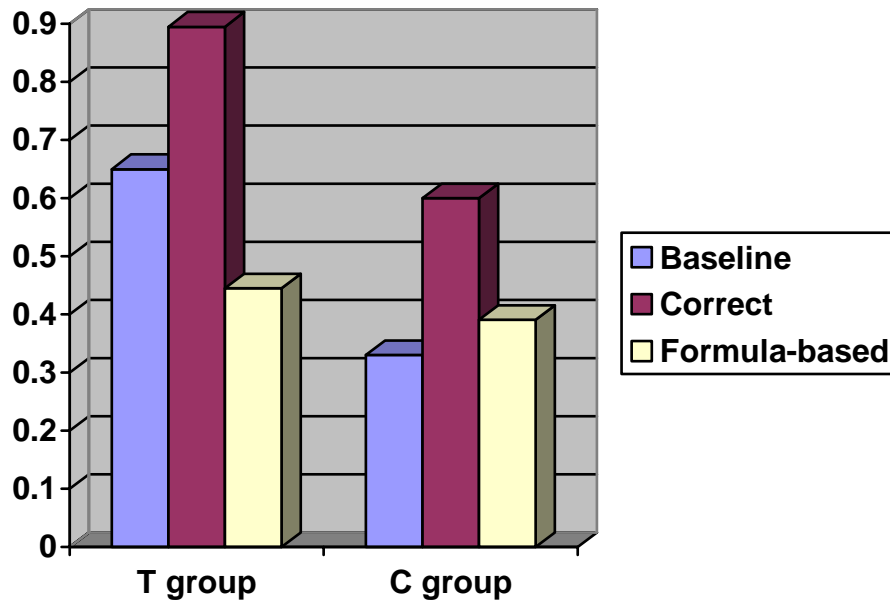
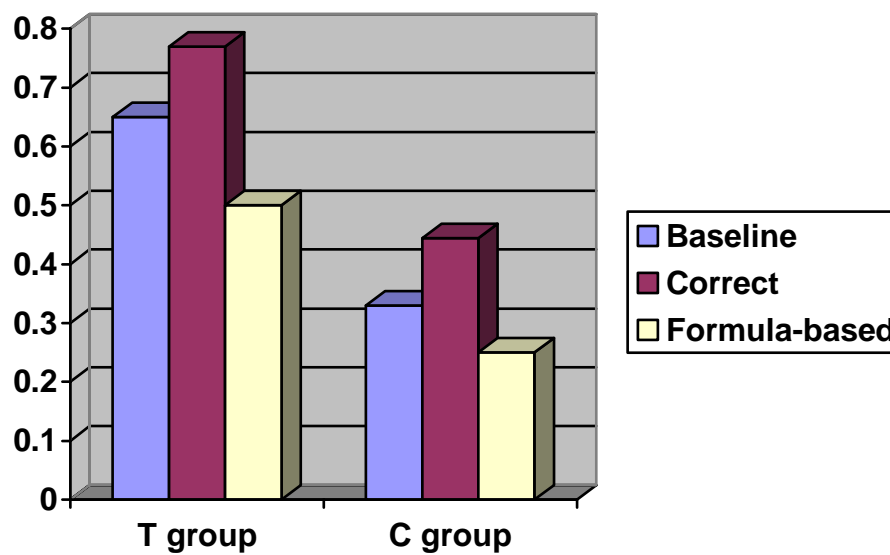

Figure 6.5b. Comparison of the C-index for the correct solution and an inappropriate formula-based solution to the electrostatics problem.



A similar pattern emerged for the electrostatics problem. The correct solution, route i, also had a large C-index for both groups, above the respective baselines. In the treatment group, 76.9% of those who chose the correct route were conceptual problem solvers. The corresponding value was 44.4% in the control group. Figure 6.5b clearly shows that also for this problem, the C-index for the correct route exceeds the baseline for each group. For route ix, the formula-based route for the electrostatics problem, 50% of the treatment group's solutions were by conceptual problem solvers, well below the 65 % baseline. In the control group, 25% of those who chose this route were conceptual problem solvers, below the 33% baseline for the control group.

### 6.1.5 Section summary

Solutions maps were developed to analyse the nature of the solutions presented in the June examination. The solutions maps provided evidence of enhanced conceptual understanding amongst the treatment group, in various ways:

- More treatment group students were able to apply general physical principles where the control group students tended to apply special case formulae that were not suitable to model the given problems.
- There was a greater tendency amongst the control group to choose formulae by matching symbols, a method indicative of a lack of conceptual understanding.
- The treatment group demonstrated an enhanced understanding of linking concepts from different domains of physics.

While the solutions maps confirmed that the treatment group developed better conceptual understanding, there was an important negative result, namely ineffective transfer to previously studied content. Viewed positively, this shortcoming actually suggested that the strategy operates firstly as a basis for developing conceptual understanding of a topic while learning new content. Once some understanding has been established, using the strategy amounts to practising the application of concepts to the problem; this develops familiarity with concepts and their applications.

The term “conceptual index” was introduced to assess the popularity of solutions routes amongst students. It was demonstrated that correct routes were associated with large conceptual indexes, above the respective baselines for both the treatment and the control group. Furthermore, the inappropriate formula-based solutions were characterized by smaller conceptual indexes, indicating that students following a conceptual approach tend to avoid formula-based routes. This was particularly evident amongst the treatment group, for whom the C-indexes were well below the baseline, in both problems. It was concluded that the problem-solving strategy enabled treatment group students to adopt a conceptual approach to problem solving, and that this approach enabled more students to follow the appropriate routes.

## **6.2 CASE STUDIES: VIDEO SESSION**

The video session provided opportunities for open-ended investigation into problem solving. It captured problem solving in action, without the time constraint that characterizes examinations. The videotapes could reveal how the problem-solving strategy was applied, giving more insight than the written solutions: it could show the way in which the solutions were constructed. While the solutions maps and conceptual approach analysed earlier provided information on the products of problem solving, the videotapes complemented this information by illuminating the problem-solving process.

The video problems were not entirely new to the students. The students were advised to work through their tests and June examination questions prior to attending the video session. Variations of problems encountered in the tests and examination were given as video problems. Students were given the set of problems on entering the room. They were then allowed a few minutes to read through the problems to choose which ones they would like to try. While working individually on solutions, they were videotaped continuously, and the written solutions were retained and used in the analysis.

The students were supposed to work quietly and on their own and to demonstrate how they constructed their solutions. It was already mentioned in Chapter 4 that the videotapes were not



intended to capture “talking aloud” while solving problems. Talking aloud would introduce a new dimension which could support the problem solving in other ways than was investigated.

The attendance of the video session was disappointing, particularly from the control group. While each school was invited to send 4 students of mixed ability, only 15 students in total turned up for the session. There were 11 students from 3 treatment group schools, and 4 students from 1 control group school. The treatment group students who attended were enthusiastic and motivated as if they had been experiencing success that they attributed to the use of the problem-solving strategy. On the other hand, the morale of the control group students who turned up was low. In fact, the two students from the control group who were videotaped performed very poorly in the video session, while most of the students from the treatment group did well.

The size and composition of the video group thus ruled out a comparison of the treatment and control group’s solutions for the video session. A case study approach was chosen to investigate the process of problem solving. Two solutions from the treatment group and one from the control group will be presented as case studies. How were the solutions selected for these case studies? Imperfect solutions were selected – this showed how the strategy provided guidance in constructing solutions. These revealed more than the “correct” solutions, which tended to be just perfect, revealing little about the process behind the product. From the control group one solution was chosen that clearly illustrated how symbol-matching can go wrong when conceptual understanding is absent.

There were also a few videos showing unplanned interruption by the researcher. When it became clear that a student was stuck, the researcher offered unplanned help in the form of leading questions. The session was thus sped up without embarrassing the student by stopping the effort. Being unplanned and assisted, these solutions were not regarded as suitable case studies in the present investigation of individual problem solving.

### 6.2.1 The accelerating charge

The video question on an accelerating charge resembled Millikan's experiment, with the difference that the charge was not in equilibrium: here a charged bead accelerated against gravity between two oppositely charged plates. It showed similarity to the electrostatics problem in the June examination, where a charged ball's weight was balanced by an electrostatic force. In both these problems, the student had to apply principles from two domains of physics, namely mechanics and electrostatics. The question follows:

#### Video, question 3

*A student tries to do the Millikan experiment by using small charged plastic beads instead of oil drops. The mass of each bead is  $4 \times 10^{-4}$  kg. He places two large, parallel metal plates horizontally and connects these to the terminals of a 5000 V source. The distance between the plates is 300 mm. The student observes one of the beads accelerating upwards at  $2 \text{ m.s}^{-2}$  to the top plate. Calculate the charge on the bead.*

#### *Solution*

*The charge accelerates upwards, meaning that the electrostatic force exceeds the weight of the particle.*

$$F_{res} = ma$$

$$F_{up} - F_{down} = ma$$

$$F_{down} = mg = 4 \times 10^{-4} \times 10 = 4 \times 10^{-3}$$

$$F_{up} = Eq$$

$$E = V/d$$

$$F_{up} = Vq/d = 5000q/0.3$$

$$Vq/d - mg = ma$$

$$5000q/0.3 - 4 \times 10^{-4} \times 10 = 4 \times 10^{-4} \times 2$$

$$5000q/0.3 = 48 \times 10^{-4}$$

Electrostatic force



Weight

$$q = 0.3 \times 12 \times 10^{-4} / 5000$$

$$q = 7.2 \times 10^{-8} \text{ C}$$

Four students attempted this question. Two were successful; one of these cases is discussed below.

### **Ntombi's solution**

Ntombi's solution to the electrostatics problem is shown in figure 6.6. She worked methodically: she even numbered her steps. All the steps of the strategy were used, except for interpretation. She wrote headings and underlined them. She interchanged the prescribed sequence of analysis and relations; she also did this in a previous problem.

#### Diagram

This diagram shows the physical objects, namely the two plates and the bead. There was one unlabelled arrow with ambiguous meaning: It could represent the acceleration, the resultant force, the electric field or the electric force.

#### Information

She listed the information, rather than indicate it on the diagram as suggested by the strategy.

#### Unknown

She identified the charge as unknown. After starting on her next step (relations), she returned to the unknown and also indicated that she would need to know the value of the electric field before she could calculate the charge.

#### Relationships

She wrote down the three equations that she planned to use: the field between parallel plates, the relationship between force and field, as well as an expression for the electrical force in terms of weight and acceleration. The latter is an application of Newton's second law, specifically for a charge that accelerates upwards against gravity. It is not a standard form found on information

Figure 6.6 Ntombi's solution to the problem of the accelerating charge in the video session.

① Diagram

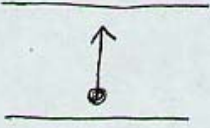

② information  
 $m = 4 \times 10^{-4} \text{ kg}$   
 $v = 5000 \text{ v}$   
 $d = 0,3 \text{ m}$   
 $a = 2 \text{ m/s}^2$

③ Unknown  
 $Q = ?$   
 $E = ?$

④ Relation  
 $E = v/d$   
 $E = F/q$   
 $F_e = ma + mg$

⑤ Analysis  
 Electrostatic force  
 & Newtons Law

6. Substitution & Solve

a)  $E = v/d$   
 $= 5000/0,3$   
 $= 1666,7 \text{ v/m}$

b)  $F_e = ma + mg$   
 $= m(a + g)$   
 $= 4 \times 10^{-4} (2 + 10)$   
 $= 4 \times 10^{-4} (12)$   
 $= 4,8 \times 10^{-3} \text{ N}$

c)  $\therefore E = F/q$   
 $1666,7 = 4,8 \times 10^{-3} / q$   
 $\therefore q = 2,9 \times 10^{-6} \text{ C}$

sheets. Writing Newton's second law as an application indicated conceptual understanding of the fact that the electrical force overcame the weight of the charge.

### Analysis

While the problem-solving strategy placed analysis before relations, Ntombi actually did it the other way round. For analysis, she wrote down "electrostatic force and Newton's law", but these were already implicit in the previous step.

### Substitute and Solve

Ntombi started by calculating the electric field and force separately, making a minor computational error in the calculation of the field, and finally calculated the charge. She did three separate calculations leading up to the answer. She kept returning to the relations written down in step 4 while doing the calculations, apparently to keep track of where she was going.

### What did Ntombi's solution reveal?

In terms of the problem-solving strategy used in this study, Ntombi clearly attempted to follow the rules of the problem-solving strategy. However, the diagram did not clearly indicate what the single arrow represented, and the two forces were not shown. The absence of physics concepts in the diagram, as well as the odd sequence of her steps 4 and 5 suggested that she did not always understand what the *purpose* of a step was. Her analysis was *written down* after she actually performed an abstract analysis in the previous step, while selecting relations. When she wrote down the analysis, she was rather confirming her choice of relations. Nevertheless, her interpretation of Newton's second law for this particular system, the planning and execution of the solution suggested understanding of the physics involved.

In the June examination, she followed route ii in her solution to the balanced charge problem, question 5.2. In this route, the concept of balancing a gravitational and electrical force was correct, but there was a mistake: she used the gravitational force between the two charges instead of the weight. Nevertheless, she was able to link gravitational forces and electrostatic forces acting on a charged particle in the June examination as well as in the video session.

## 6.2.2 The pendulum-collision problem

The problem set included a variation of the well-known problem of a bullet shot into a swinging block. Here a toy gun fired a bullet into an apple hanging from a string; the students had to calculate the height reached by the swinging apple. The question was not subdivided, requiring the students to identify and link the parts without guidance from the question structure. The problem resembled a question in the March test, in which a trolley rolled downhill into a stationary trolley at the bottom of the slope. The video problem follows:

### Video, question 2

*An apple with mass 95 gram hangs in rest from a long string. The string is tied to a branch so that the apple can swing without any friction. A toy gun fires a 5-gram bullet horizontally at  $40 \text{ m}\cdot\text{s}^{-1}$  into the apple. The bullet stops inside the apple while the apple swings upwards.*

*Calculate the maximum height the apple reaches above the original position.*

### *Solution*

*When the bullet hits the apple, momentum is conserved*

$$p = \text{constant}$$

$$m_A v_A + m_B v_B = (m_A + m_B)v$$

$$0 + 5 \times 40 = (5 + 95)v$$

$$v = 2 \text{ m/s}$$

*This is the speed of the apple after the collision, and also the speed at which the apple starts swinging. Swinging from bottom to top, mechanical energy is conserved:*

$$E_P + E_K = \text{constant}$$

$$mgh_T + \frac{1}{2}mv_T^2 = mgh_B + \frac{1}{2}mv_B^2$$

$$gh_T + \frac{1}{2}v_T^2 = gh_B + \frac{1}{2}v_B^2$$

$$10 h_T + 0 = 0 + \frac{1}{2} \times 2^2$$

$$h_T = 0,2 \text{ m}$$

*This is the height the apple reaches above its original position.*

Of the seven students who chose to do this problem, five were successful. The solutions of two students are presented: Sam from the treatment group, and David from the control group. Sam, who used the strategy partly, followed a conceptual approach and solved the problem correctly. David made a very poor formula-based attempt.

### **Sam's solution**

Sam's solution is shown in figures 6.8a and 6.8b. The division was made by the researcher in order to fit the solution on two pages. Although Sam did not explicitly write all the headings of the strategy, the steps of the strategy were visible in his solution. He also deviated from the sequence of strategy by returning to previous parts of his solution before going back to where he left off. Sam's solution shows how he applied the processes of the strategy even though most headings were not written. In the discussion below, the headings, which he omitted, are given in brackets to indicate the relevant steps and to show where he returned to previous steps.

#### (Diagram)

Sam started by drawing the toy gun and the apple hanging from a string. The apple was shown in two positions, the original as well as at the top of the upswing. He did not draw the bullet itself, but drew a small arrow representing the bullet.

#### (Information)

Sam indicated the mass and speed of the bullet (lines 4-left and 6-left) in the vicinity of the gun and arrow. He converted the mass of the bullet (incorrectly) to kg on the sketch (line 4-left). He indicated the mass of the apple, converted it to kg (line 5) and also indicated that the apple was originally at rest (line 4-center).

#### (Unknown)

At this stage he identified the height reached by the apple as the unknown variable and indicated it on his diagram (line 4-right).

Figure 6.7a. First part of Sam's solution to the problem of the pendulum-collision in the video session.

1  
2  
3  
4  
5  
6  
7  
8  
9  
10  
11  
12  
13  
14  
15  
16  
17  
18

$m_1 = 0,05 \text{ kg}$   
 $u = 40 \text{ m} \cdot \text{s}^{-1}$

$u_1 = 0 \text{ m} \cdot \text{s}^{-1}$   
 $m_2 = 95 \text{ g} = 0,095 \text{ kg}$   
 $E_k + E_p = K$   
 $0,2 + 0 = 0,2 \text{ J}$

$\therefore E_k + E_p = 0,2 \text{ J}$   
 $0 + E_p = 0,2 \text{ J}$   
 $\therefore E_p = 0,2 \text{ J}$

$u = ?$

Analysis: there is collision so, conservation of momentum. The apple swing, therefore pendulum method stimulated.

$u = ?$

Conservation of momentum.  
 Momentum before = Momentum after.  
 $m_1 u_1 + m_2 u_2 = v(m_1 + m_2)$   
 $(0,05)(40) + (0,095)(0) = v(0,05 + 0,095)$   
 $0,2 + 0 = v(0,1)$   
 $\frac{0,2}{0,1} = \frac{v(0,1)}{0,1}$   
 $v = 2 \text{ m} \cdot \text{s}^{-1}$



Analysis

Sam then proceeded to write down his analysis (lines 8-10), indicating it with a heading. This was the first time that he made explicit reference to one of the steps in the problem-solving strategy. He clearly identified two events and the particular domain of physics that applied to the each event. He did not indicate how the two parts of the motion were linked. In line 11 he again indicated the unknown height. Lines 12 and 13 were actually a continuation of the analysis, applicable to the first event, but his layout suggested that he did not regard it as such.

(Relationships)

Line 14 was an algebraic expression of the momentum conservation law for this particular type of collision. Here Sam used subscripts to distinguish between the two different objects.

(Substitution and Solution)

He substituted the given data in line 15. (The researcher interrupted to correct the conversion error for the mass of the bullet in order to keep the numeric work simple.) Sam proceeded and calculated the speed of the apple (with bullet inside) after the collision (lines 16-18). He did not indicate why he needed to calculate this speed. He made a mistake with units, writing units for acceleration instead of units for speed.

(Back to analysis)

In line 19, Sam stated in writing that energy conservation should now be applied.

(Formula)

In line 20, he expressed energy conservation in symbolic form, referring to the sum of kinetic and potential energy, at the bottom and at the top. In line 21, he wrote the standard expression for kinetic energy.

(Substitution and solution)

In line 22 he substituted the speed and mass for the combination immediately after the collision. This substitution suggested conceptual understanding of the link between the two parts of the

Figure 6.7b. Second part of Sam's solution to the problem of the pendulum-collision in the video session.

19 Conservation of energy  
 20  $E_k + E_p \text{ (at bottom)} = E_k + E_p \text{ (at top)}$   
 21 At the bottom.  $E_k = \frac{1}{2}mv^2$   
 22  $= \frac{1}{2}(0,005 + 0,095 \times 2)^2$   
 23  $= \frac{1}{2}(0,1 \times 4)$   
 24  $= \underline{0,2 \text{ J}}$   
 25 At the top.  $E_k = 0$   
 26  $E_p = mgh$   
 27  $m = 0,1 \text{ kg}$   
 28  $g = 10 \text{ m} \cdot \text{s}^{-1}$   
 29  $E_p = 0,2 \text{ J}$   
 30  $h = ?$

31 Substitution:  $E_p = mgh$   
 32  $0,2 = (0,1 \times 10)h$   
 33  $\frac{0,2}{1} = \frac{1h}{1}$   
 34  $\underline{h = 0,2 \text{ m}}$

35  $\therefore$  The maximum height of the apple  
 36 is  $\underline{0,2 \text{ m}}$ .

motion, even though he did not explicitly refer to the link. In lines 22-24 he calculated the kinetic energy at the start of the upswing as 0.2J.

(Back to analysis/diagram)

Sam returned his attention to his diagram and continued working on the diagram itself. In lines 6-center and 7, he concluded that the total energy at the start of the swing was 0.2J. He then focused on the top of the swing (line 1-right), and applied the principle of energy conservation: he actually wrote the “therefore” symbol and stated that the sum of potential and kinetic energy should here too be 0.2 J. He then concluded (lines 2 and 3) that the potential energy at the top was 0.2 J.

(Forward to analysis)

In line 25, Sam returned to his written solution. He repeated that the kinetic energy was zero at the top of the upswing. The layout suggested that the remainder of the solution referred to the apple’s highest position.

(Relationships)

In line 26 he wrote the standard formula for gravitational potential energy.

(Back to information)

In lines 27-29 Sam routinely listed the information for the remainder of the problem. He now included potential energy in the list (line 29), while this was actually a variable he calculated in line 3, on his return to the diagram. This list is typical of algebraic problem solving; yet here it may have served as consolidation of the information that he has assembled while constructing his solution.

(Unknown)

In line 30, he restated that the height was unknown.

(Forward to substitution and solution)

Lines 31-34 showed algebraic calculation of the unknown height, using the standard formula for potential energy.

(Interpretation)

Lines 35-36 related the numeric answer to the original question.

What did Sam's solution reveal?

In the March test, Sam had a similar question wrong; then he treated the entire problem by only applying momentum conservation. He used a diagram, but did not give other evidence of using the strategy. In the video session he used a detailed diagram and written analysis and was able to identify the two parts of the problem correctly. Although he did not apply the strategy perfectly, he followed a conceptual approach, guided by the strategy.

An expert may regard Sam's approach as a time consuming detour. It would be much shorter to write one equation for energy conservation in terms of speed and height and then simply substitute and solve. Sam chose to work in smaller steps, the remainder of the solution was probably not clear to him. He used three separate equations to express the concepts of kinetic and potential energy, and energy conservation, thereby doing the calculation in smaller units. Returning to the diagram, suggests that he actually interacted with his diagram to implement the energy conservation principle.

Sam's solution showed how the problem-solving strategy guided him to use visual, text and symbolic representations to think his way through the solution. The way in which he repeated the cycle for the second part of the motion showed cognitive engagement while working towards a solution. He did not see the solution in a flash; he rather constructed a solution in small units, one step at a time. Such construction of a solution amounts to learning; this is how students could learn to understand physics concepts when applying the problem-solving strategy throughout the course.

**David's solution**

David, a student from the control group, chose to try the pendulum-collision problem. His solution (figure 6.8) was completely wrong, but was included as an illustration of an inappropriate formula-based approach, not as a comparison between the two groups. It was mentioned before that the attendance of the video session was not representative of the two groups.

Figure 6.8. David's solution to the problem of the pendulum-collision in the video session.

<u>Data</u>	<u>Cal.</u>
$m_1 = 95 \text{ g}$	$P = m v$
$m_2 = 5 \text{ g}$	$= 100 \text{ g} \times 4 \text{ m.s}^{-1}$
$v = 40 \text{ m.s}^{-1}$	$= 400 \text{ N}$
$F = 400 \text{ N}$	
	$F = G \frac{m_1 m_2}{r^2}$
	$400 \text{ N} = \frac{6,7 \times 10^{-11} \times 95 \times 5}{r^2}$
	$400 \text{ N} = \frac{3,1 \times 10^{-8}}{r^2}$
	$r^2 = \frac{3,1 \times 10^{-8}}{400}$
	$= 7,75 \times 10^{-10}$
	$r = \sqrt{7,75 \times 10^{-11}}$
	$= 8,8 \times 10^{-6} \text{ m}$

David simply matched symbols to information and selected a formula that seemed suitable. He chose the universal gravitation law, probably because it involves two masses and a distance, thus resembling the bullet, the apple and the unknown height. The incorrect substitution of momentum for force further demonstrated a lack of conceptual understanding. In this problem, the formula-based approach did not work. However, in many cases it can yield the required result, particularly in simple problems consisting of only one part.

### 6.2.3 Section summary

The video solutions showed clearly that the problem-solving strategy was useful even when not applied in a rigid fashion. The benefit of the strategy was demonstrated as promoting conceptualization while solving problems.

During the analyses of these video solutions it became clear that classifying solutions to assess problem-solving skill was a complex task. How would these solutions be assessed in terms of the expert/novice problem-solving literature? The two successful candidates would be regarded as "more experienced" as they were working "forward" (Simon and Simon, 1978). Sam's diagram exhibited "deep structure" associated with experts, (Chi, Feltovitch & Glaser, 1981) while Ntombi's diagram resembled a novice's naïve representation of physical objects, lacking physics representation (Larkin, 1983). Sam's analysis represented the qualitative physics description (Larkin & Reif, 1979), or physics representation (Larkin, 1983), which was typical expert problem-solving behaviour. Regarding planning of the solution, Ntombi did best, and could be called a good problem solver (Feingold & Mass, 1985), while Sam could be called a poor problem solver.

Each of the two treatment group students' solutions has some expert and some novice features. Many questions remain unresolved. Does the absence of a conventional force diagram reflect poor understanding, or poor training? Does a poor diagram, exhibiting only surface features, imply that the student did not conceptualize, or does it imply that this student's concepts are not strongly visual? Does the fact that Newton's second law was not written in standard form mean that the student didn't understand the meaning of the equation that she wrote? How can one tell whether a mathematical equation represented a physics concept to a student? To answer these questions would require more investigations.

Perhaps a different question should be asked about solutions, namely whether they demonstrate understanding of the physics involved. This brings us back to the two main goals of problem solving in physics: learning physics and assessment of the learning. Sam's solution demonstrates how the use of the strategy guided him to construct solutions that were not immediately clear to

him. Similarly, regular use of the strategy during the physics course could guide students in learning the meaning, implications and application of physics concepts and principles. Ntombi's solution demonstrates how using the strategy provided a guide to present her understanding. Even though her analysis was *written* after the fact, it served as a confirmation of the relevance of the relations she had already chosen, thus providing feedback in the learning cycle.

When assessing students' solutions, the standard practice in South African schools and external examinations is to give marks for correct algebra, thereby not encouraging conceptualization. This promotes formula-based solutions that undermine the first goal of problem solving, namely learning the principles of physics. The time constraint in examinations also prevents students from working their way through more difficult problems. This could lead to a vicious cycle with examinations tending to shift emphasis to algebraic solutions at the expense of conceptual understanding. In such a vicious cycle, assessment of learning actually undermines learning.

### **6.3 QUESTIONNAIRES**

The test results indicated that the treatment group scored significantly better than the control group. The solutions maps indicated that the treatment group had better conceptual understanding. It was shown that the treatment group had developed a conceptual approach to problem solving. Was the task accomplished? What did the teachers and students think of the problem-solving strategy? If those who were to implement the problem-solving strategy were sceptical and/or reluctant, teaching such a strategy would be a futile exercise. It was, therefore, necessary to probe the attitudes and beliefs of teachers and students to establish whether they would adopt the strategy as a way of working.

The March questionnaire was given to all the treatment group students. The video group had another questionnaire right after the video session in October and the teachers were given a questionnaire in November, at the end of the academic year. The questionnaires included multiple choice items as well as open-ended questions.

### 6.3.1 Treatment group's questionnaire

The March questionnaire revealed a generally positive attitude towards the problem-solving strategy amongst the treatment group students. When asked whether they believe that their problem-solving skills had improved, 69% answered yes, 25% was unsure while only 6% reacted negatively. Most of the students said that they would keep on using the strategy even if their teachers said that it was not necessary. Amongst the learners, 62% said that they would keep on using it, 19% said they would use it for difficult problems and another 19% said they would stop using it. The students seemed to have applied the strategy frequently when doing homework: 59% used it for most problems, 25% used it for difficult problems while only 16 % said that they seldom used it. Overall, these responses indicated that less than 20% were negative about the strategy.

Using the strategy seemed to shift the focus from formulae to understanding. When asked for an opinion on the strategy, 53% said that the strategy helped them to understand the problems; 25% believed that it helped them to find the right formula, 11% said that it sometimes helped and only 11% said that it was a waste of time. The comments listed below suggest improved understanding due to the use of the strategy:

“By doing the strategy it puts a picture in your mind.”

“It helps me to find the way to solve and understand what I am doing.”

”I think the problem-solving strategy is playing a big role in my physical science and I am going to use it always.”

“It makes me be used to the formula.”

“It shows me the picture of what it look like and how to do it.”

“In the past it took me a long time to identify the topic of the problem.”

“Using it really simplifies things.”

“I understand the problem because I can see it on the drawing.”

These remarks indicated that the fixation on formulas was not completely erased, but some comments also referred to understanding and concepts.



Despite the positive response, there was some concern for time spent on writing down the steps of the strategy:

“It does truly take time but at the end it is an advantage to me because I'll understand the work more and be successful in solving the problems.”

“All those drawings and data take a lot of time in a test.”

“I only use it when necessary because it takes quite some time.”

There were a few students who considered the strategy a waste of time, *because* they did not earn any marks for writing the steps:

“Because there is no marks on the strategy and I spend more time on it.”

“I spend most of my time commending and drawing diagrams that have no marks”.

“Because when doing it you don't get marks for it.”

Apparently these few students did not actually understand the purpose of using the strategy.

Male and female students generally answered similarly, with two interesting exceptions: More male (73%) than female (63%) students believed that their problem-solving *skills* had improved. On the other hand, more females (59%) than males (49%) said that the strategy helped them *understand* the problems. These two differences might suggest that the male students were more task orientated than the females.

### **6.3.2 Video groups' questionnaire**

All the students from the treatment group who attended the video workshop believed that their *understanding* of physics had improved, as illustrated by the following comments:

“The strategy edged me to know why we say words like momentum is conserved.”

“I used to hate physics more than chemistry, now I enjoy physics.”

“It taught me that physics is not only about finding the right answer, but it is also about understanding your solution.”

Regarding their earlier methods of problem solving, the analysis was new to all the students; some also mentioned “diagram” and “interpretation” as new ideas. One student described his

previous approach as follows: “I just wrote down a few formulas that I could use, looking at the information.” Such a change represented a shift from an algebraic to a conceptual approach.

Most of the students mentioned that the writing down of the steps took too long during examinations. Yet they were positive about learning the strategy, and they believed that they had an advantage over students who did not learn the strategy:

“...like a guide keeping you on the right track.”

“...especially when practicing problems or studying.”

“...it leads us to the right equation.”

“...you know what kind of a question you are dealing with.”

“...the analysis helps you to link the problem with different parts of the syllabus...”

It appeared that students valued the strategy for the benefit of its regular use rather than as a quick fix for examinations. There were suggestions that the strategy led them to discover patterns in types of problems and solutions. It seemed that students indeed became more aware of the qualitative meaning of solutions and they showed improved understanding for concepts used in their solutions.

### **6.3.3 Teachers' questionnaire**

The teachers were generally positive about the strategy, believing that their students' as well as their own problem solving had improved.

All eight teachers in the treatment group agreed that students who learnt the strategy had an advantage over students who did not. The comments below summarized the response:

“...realized that a certain pattern of thinking is required to solve problems.”

“It allows the learner to virtually see the problem and solutions connecting to the problem...”

“They discovered that physics is not as complicated as they usually thought.”

“...makes the starting point easier.”

Some of the teachers mentioned that some of their students avoided the strategy in examinations because of limited time. One teacher observed that "some of the more able learners gave the impression that the strategy was too time consuming – perhaps they did not see the value of analysing the problems thoroughly." This teacher clearly saw analysing as a valuable exercise.

Regarding their own problem-solving ability, all the teachers believed that teaching the strategy to their students improved their *own* problem-solving ability. One said that she "gets to understand exactly what the problem is about." This suggested that the teacher's own conceptual understanding had improved. Another said that "it became easy as no rough work was necessary." It was not clear what this rough work actually meant: It could have meant picking a formula or it could imply a physics representation. Either way, having learnt to include diagrams and analysis as an integral part of the solution, indicated improved conceptualization. Both these teachers thus indicated that their improved problem-solving skills had developed through enhanced conceptual understanding.

Regarding their previous approach to problems, three of the teachers used to teach their students to list the data when starting problems, typical of algebraic problem solving. One teacher said that he always encouraged sketch drawing, but having students formulate ideas was new. The other four teachers mentioned no specific previous ways of approaching problems. This suggested that only one of the teachers previously encouraged some conceptualization in solving problems.

Would they implement the strategy in future? Four said that they would use all the steps, two would use analysis and interpretation, one would use only the diagram and one said that she would just list the data as before. This meant that seven of the eight teachers regarded aspects of the problem-solving strategy as a viable classroom practice.

#### **6.3.4 Section Summary**

The questionnaires were meant to probe attitudes; they were not meant to be exact scientific instruments. The majority of treatment group students were of the opinion that their problem-

solving skills and understanding of physics had improved. Most of the teachers held similar opinions about their students. Moreover, the teachers also believed that their own problem-solving skills and understanding had improved. Students often referred to the value of the diagram, and some commented that the strategy helped to find the relevant physics principles. Students as well as teachers generally indicated that they would keep on using some aspects of the problem-solving strategy. This indicated that the problem-solving strategy was regarded a viable practice, not just a short-term experiment.

#### **6.4 CHAPTER SUMMARY**

In this chapter, solutions maps, videos and questionnaires indicated that the test group had developed better conceptual understanding of physics through the implementation of a structured problem-solving strategy.

- Questionnaires indicated that teachers as well as students believed that they had acquired better understanding. Students made more reference to understanding than to formulae, suggesting some shift in student's views on the essence of problem solving.
- In the video session, the strategy was not always perfectly applied. Sometimes steps were not indicated, sometimes they were interchanged. The principles of physics were not always applied elegantly, diagrams did not always exhibit all relevant physics concepts, analyses were often brief. Yet the students demonstrated conceptual understanding by making appropriate translations between different representations. They also formulated their understanding by writing analyses instead of just plunging into algebra.
- The solutions maps demonstrated improved conceptual understanding amongst the test groups through the use of general principles of physics. On the other hand, the control group tended to make more use of special case formulae and inappropriate formula-based solutions.
- The solutions map for the electrostatics problem showed that the treatment group had an enhanced ability to link concepts from different domains of physics, indicating understanding of the interrelatedness of phenomena.

Apart from clear indications of enhanced conceptual understanding, the results of this chapter also indicate that the problem-solving strategy acts as a tool for learning:

- The solutions maps revealed an important negative result, namely ineffective transfer to previously studied content. This result actually suggested that the strategy should be viewed as a way of learning to understand the meanings of physics concepts. Successful problem solving thus follows because of enhanced conceptual understanding.
- Although the steps of the strategy were seldom explicitly indicated in the June examination, there was evidence that the treatment group had learnt to conceptualize when solving problems. Conceptual indexes showed that a conceptual approach was well represented in the correct routes on solutions maps, and under-represented in the inappropriate formula-based routes. It was thus concluded that the enhanced success of the treatment group could be ascribed to their learning how to conceptualize instead of matching symbols.
- One student commented in a questionnaire that the structured problem solving was valuable while studying.

The video session showed that application of the strategy need not be elegant nor perfect in order to arrive at a correct solution. Working through the steps keeps the students aware of what is required in each step; the students necessarily became mentally engaged in linking physics concepts to reality.

Despite students' complaints that the writing of steps took too much time during examinations and that they got no marks for the steps, teachers as well as students believed that they had acquired better understanding. Not writing the steps to save time during the examination did not prevent success. Solutions indicated that the students had indeed developed a conceptual approach to physics problems. The success in the examination relied on conceptual understanding developed during the year when the strategy was implemented, as well as the conceptual approach followed during the June examination.

## CHAPTER 7

### SYNTHESIS

This study extended existing research on structured problem solving into disadvantaged South African classrooms. Research conducted in the first world showed that students' problem-solving skills had been improved by problem-solving strategies that encourage the use of successive representations. The current results indicated a similar improvement amongst *disadvantaged students*. In addition, enhanced conceptual understanding was demonstrated. Evidence suggested that enhanced problem-solving performance depended on the development of conceptual understanding while applying the strategy. In addition, the formal structure of the strategy was seldom visible in solutions, but instead, the treatment group demonstrated increased use of a conceptual approach to problem solving.

The chapter is organized into three parts, starting with an interpretation of the results. Next, a discussion of the significance of the study for development in disadvantaged schools will be presented. Finally some recommendations will be made for the implementation of the structured problem-solving strategy.

#### 7.1 INTERPRETATION OF RESULTS

What was the effect of the structured problem-solving strategy in physics on scores and conceptual understanding, when tested in disadvantaged South African Schools? How can the results be explained? Seven claims will be presented, leading to two complementary theories on the effect of the strategy.

##### 7.1.1 Claims

Statistical analysis of overall scores indicated that the treatment group scored significantly higher than the control group. The better scores resulted from better solutions by the treatment group: the

marking was in no way biased towards the problem solving-strategy itself, as no marks were allocated for writing steps of the strategy, nor for additional diagrams and written explanations. In fact, the marking was done in accordance with departmental examination standards. The scores obtained by individual students correlated well with their scores for the external preliminary examination set by the department of education. It was thus concluded that the treatment group's higher scores for answers to problems could be attributed to better solutions, not to biased instruments or procedures. The first claim answers the first research question.

*Claim 1: Implementing the strategy resulted in enhanced problem-solving performance.*

Qualitative evidence from solutions maps, videotaped problem solving and questionnaires suggested enhanced conceptual understanding amongst the treatment group. Questionnaires revealed that most of the students believed that their understanding of physics principles and their applications had improved. Furthermore, there were remarks that specifically referred to the value of diagrams and explanations in understanding the problems, principles and solutions.

Video case studies of the treatment group students showed how solutions unfolded. The steps of the strategy were not always applied in the prescribed sequence, and students sometimes returned to previous steps before proceeding. Sam and Ntombi's "imperfect" solutions actually demonstrated how the steps of the strategy guided them to make connections between knowledge domains while constructing their solutions. Even though the strategy was not applied in a rigid fashion, it provided scaffolding through which students were enabled to express their thoughts and apply their understanding of how physics concepts related to the given concrete problem situations.

Detailed analysis of solution maps revealed the treatment group's enhanced conceptual understanding in various ways:

- The treatment group used general physics principles to a greater extent, while the control group tended to use special case formulae, which were not applicable to the given situations.
- The tendency to follow inappropriate formula-based routes was reduced amongst the treatment group.

- The treatment group showed an enhanced ability to construct solutions, which required integration of different domains of physics. Such integration of topics requires conceptual understanding of the relevant topics as well as their relatedness in the particular situation.

Qualitative evidence from three sources thus answered the second research question and supports the second claim.

*Claim 2: Implementing the strategy resulted in enhanced conceptual understanding.*

No treatment effect was observed for the topic of kinematics, which was, as explained in section 4.3, studied during the previous year. On the other hand, there was a significant treatment effect for topics studied during the period in which the strategy was implemented. It was thus argued that the problem-solving strategy was poorly transferred to content studied prior to learning the strategy. The failure to transfer the strategy to content studied previously, suggested that conceptual understanding develops while applying the strategy to problems on new content. The following claim is made:

*Claim 3: Enhancement of problem-solving performance depended on the development of conceptual understanding while learning new content.*

In the tests and examination, the actual steps of the problem-solving strategy were seldom written down explicitly. Reasons given by students for bypassing the strategy in the examination were time constraints as well as the conventional marking scheme. How could the enhanced performance of the treatment group be attributed to structured problem solving if the students seldom used the steps? It was argued that the effect of practising the strategy during the semester would be visible as "footprints" in solutions presented in the examination. Such footprints took the form of diagrams and verbal arguments that were not explicitly required by questions. The presence or absence of the footprints in solutions was used for the classification of the approach as either conceptual or algebraic. A classification of students as either conceptual or algebraic problem solvers, made it possible to quantify the extent to which treatment group students were influenced in applying aspects of the problem-solving strategy.



How could it be inferred that the conceptual approach was a result of the treatment? Anybody can decide to draw a diagram or give an explanation. In fact, there were conceptual problem solvers in the control group as well. But the difference was in the numbers: conceptual problem solvers accounted for 65% of the treatment group, as opposed to only 35% of the control group. These figures support the next claim.

*Claim 4: Implementing the strategy fostered the development of a conceptual approach to problem solving.*

Could the increased use of a conceptual approach be linked to the treatment group's higher scores? It was indeed the case: successful conceptual problem solvers accounted for 35% of the treatment group, but less than 13% of the control group. On the other hand, unsuccessful algebraic problem solvers accounted for more than 60% of the control group, but only about 30% of the treatment group. These figures support the next claim.

*Claim 5: The enhanced performance of the treatment group resulted from increased use of a conceptual approach.*

Claims 4 and 5 given above link the treatment with the conceptual approach and enhanced problem solving, suggesting a causal relationship, expressed as claim 6.

*Claim 6: The implementation of the strategy resulted in the increased use of a conceptual approach to problem solving, which enabled the treatment group students to perform better in problem solving.*

Was there some correspondence between the conceptual approach and conceptual understanding? The solution maps were analysed in terms of the conceptual approach. The term "conceptual index" was introduced to quantify the popularity of routes amongst conceptual problem solvers. It was demonstrated that correct routes were relatively popular amongst conceptual problem solvers – in the treatment group as well as the control group. On the other hand, inappropriate formula-based routes were relatively unpopular amongst conceptual problem solvers in both groups. The next claim is supported by the fact that a conceptual approach was directly related to conceptual understanding, for both groups.

*Claim 7: A conceptual approach to problem solving enhanced conceptual understanding.*

The seven claims above converged towards two complementary theories:

- (1) Implementing the strategy fostered the co-development of conceptual understanding and problem-solving skills.
- (2) Implementing the strategy fostered the development of a conceptual approach to problem solving. A conceptual approach reduced the dependence on the formal structure of the strategy, while preserving the co-development of conceptual understanding and problem-solving skills.

These two theories are discussed in the following two sections.

### **7.1.2 The co-development of conceptual understanding and problem-solving skills**

Conceptual understanding of physics can be modelled by a network of links between physics concepts and concrete situations. Problem-solving skills can be modelled as the search for and the successful application of appropriate physics principles to describe a particular concrete situation. It is proposed that implementing the strategy enhanced the co-development of the network of links and the skills to search for and apply appropriate links.

When the strategy was implemented in disadvantaged classrooms, the prescribed steps prompted unfamiliar actions: In the first three steps, the written problem statement was translated into a schematic representation of the concrete situation, with abstract concepts, symbols and information indicated. The schematic representation was then translated to appropriate physics concepts. Then followed a translation to the symbolic-language representation in order to formulate how the concrete situation was connected to physics concepts. Next, the symbolic-language representation was translated to a symbolic-mathematical representation, which was solved algebraically. Finally, the mathematical solution was translated back to the concrete and symbolic-language domains.

It is proposed that the repeated translations between the four knowledge domains had two related outcomes. For a particular problem, it created links between a particular concrete situation and particular physics principles. For a collection of problems on a topic, it created links between one particular physics principle and different concrete situations. The network of links that had

developed amounted to conceptual understanding of a topic. The ability to translate between knowledge domains in order to link a particular concrete situation with physics principles amounts to problem-solving skill. The network and the method developed simultaneously, growing from simple concepts and simple problems to a broader conceptual understanding and skilful problem solving.

### **7.1.3 The development of a conceptual approach to problem solving**

Following the steps of the strategy empowered disadvantaged students to step out of the confines of the symbolic knowledge domain during problem solving. The symbolic-mathematical knowledge domain is introduced towards the end of the procedure. Before translating to mathematics, the symbolic-language, concrete, model and abstract domains are linked to construct the diagram and perform the analysis. A non-mathematical understanding of the situation and the relevant physics concepts is thus established before employing mathematics. The problem-solving strategy thus develops an ability to relate concrete problem descriptions in terms of abstract physics principles, before applying mathematics. Furthermore, the solution does not stop with mathematics. Instead, the last step of the strategy takes the student back to the domains of concrete, abstract and symbolic-language knowledge, to interpret the meaning of the mathematical answer. Algebra amounts to only one step out of seven, while making connections between concrete situations and physics concepts takes centre stage. It is proposed that the low priority that the strategy places on mathematics creates a new understanding of what a solution entails. The construction of diagrams and the formulation of arguments become the focus of the solution, while mathematics merely takes care of numerical detail.

It is proposed that in the course of time, some students realized that the steps of the strategy were road signs to solutions, not the road itself. Once they knew how to utilize the four domains of knowledge when constructing solutions, they discarded the formal structure of the strategy. Other students omitted headings to save time, while others simply forgot the headings, while retaining the useful habits. It is even plausible that students, who were reluctant to use the strategy, could have picked up the skill of a conceptual approach, simply by being exposed to the application of the problem-solving strategy in the classroom situation. The formal structure of the strategy may

therefore make way for diagrams and arguments as part of solutions, bearing testimony of linking the concrete situation with physics principles.

The implementation of the strategy in disadvantaged classrooms thus supplied scaffolding for the development of a conceptual approach. Algebraic problem solvers adopted a conceptual approach due to a shift of focus and new skills that developed when they reacted to the prompts supplied by the steps of the strategy. Regardless of whether students kept using the formal structure of the strategy or whether they adopted a conceptual approach, the co-development of conceptual understanding and problem-solving skill would result. The conceptual approach creates and utilizes links between the four domains of knowledge in the same way as is prescribed by the steps of the strategy.

It should be emphasized that any student who mimics a good teacher or a good textbook can develop a conceptual approach. In fact, the conceptual approach was not limited to the treatment group, but it was more prominent in the treatment group and it coincided with enhancement of performance as well as conceptual understanding.

## **7.2 SIGNIFICANCE OF THE STUDY**

Implementing the structured problem-solving strategy can make a valuable contribution to develop physics teaching and learning in disadvantaged South African schools. The expectation that the teacher should be the source of knowledge can be exchanged for an expectation that students should participate in knowledge construction. Second language development would follow as a by-product of classroom discourse. The same benefits are possible in similarly disadvantaged schools in other African countries.

### **7.2.1 Social knowledge construction**

The steps of the problem-solving strategy require new patterns of behaviour in classrooms. The teacher facilitates problem solving in the classroom, rather than solve sample problems in an expository style. Instead of announcing what the formula is, the teacher encourages argumentation

to establish which principles would be applicable to the problem. The teacher's authority is replaced by the authority of physics principles.

The students' roles change from passive receivers of knowledge to active participants in knowledge construction. The strategy requires that the students react to prescribed steps, making decisions of what needs to be done in each step while working on a problem. The strategy thus presents intellectual challenges to employ all four of Greeno's knowledge domains on a given problem situation. This intellectual engagement is not limited to individual efforts. Arguing the relevance of particular principles to given situations amounts to social knowledge construction. Passivity is therefore replaced by active mental engagement, in social context as well as on an individual basis.

Investigation of classroom practices was beyond the scope of this study. Although it seems plausible that a structured problem-solving strategy can act as an agent to develop classroom practices, investigation should be carried out to explore the extent of such development.

### **7.2.2 Second language development**

Second language instruction places limitations on conceptual understanding and problem solving. The significance of the language barrier has been demonstrated in South African schools (Howie, 2003). It is envisaged that structured problem solving can be instrumental in eroding the language barrier in physics.

Poor command of the language of instruction invariably leads to algebraic problem solving. Instead of understanding a problem situation as described in the b-level of Greeno's symbolic domain, some isolated words in the a-level are understood. Consequently, translations to other knowledge domains would be incomplete, focusing on separate items in a-levels instead of meaningful arrangements of items in b-levels. Students thus resort to the option of matching individual words to symbols, and then selecting a formula to match the symbols. This is algebraic problem solving, enforced by second language instruction, not to be confused with the "isolation of symbolic knowledge", as explained by Greeno (1989).

Algebraic problem solving, enforced by second language instruction, can be challenged by the structured problem-solving strategy used in this study. The strategy was designed to prompt students to talk about physics and to formulate their thoughts in writing when performing the analysis. Following Roth (1996), it is proposed that language and understanding can evolve simultaneously, in this case amongst second language students discussing physics problems. Regarding other steps of the strategy, translations between the four knowledge domains may be incomplete and inaccurate, but valuable. Repeated exposure to phrases in different situations would add new associations to existing ones across the four knowledge domains. Students would thus make sense of new ideas and phrases in terms of existing ones, thereby taking ownership and making some sense of the language and meanings of physics.

Questionnaires revealed students' appreciation of a new understanding of the language of physics, one student remarked as follows: "...now I know why we say words like momentum is conserved...". Although such a remark is supportive, much research could be done to explore how structured problem solving can foster simultaneous development of a second language and physics concepts.

### **7.3 RECOMMENDATIONS**

The implementation of the problem-solving strategy in the eight treatment group schools was a relatively small intervention, which produced significant gains in students' performance. The teachers attended a total of only four workshops of 90 minutes each during the first semester. The students or teachers required no additional study materials, and no additional classes for students were required. The treatment simply amounted to adopting a new approach to problem solving. It is therefore recommended that the problem-solving strategy be implemented as a small intervention that can improve teaching and learning of physics in disadvantaged schools.

Should the problem solving strategy be implemented in more schools, teachers should be trained as was done during the four teacher workshops for the current study. An expert would be required for such training. Content-specific workshops should be coordinated to take place just before new

topics are to be studied. Suitable examples should be selected for the workshops. The examples should provide practice of how the strategy should be applied without proceeding to the algebraic phase of solutions. The challenge to the expert would be to help teachers discover that problem solving takes place in the conceptualizing phase, preceding the algebraic phase.

Teacher development in disadvantaged schools is an implicit advantage of the implementation of the problem-solving strategy. Teachers acquire new skills during the training workshops – skills that could develop further during interaction with their students. The teacher-dominated lessons from the past can thus be replaced by teacher-facilitated lessons, as discussed previously. Apart from attending the workshops for training, teachers can utilize existing teacher support groups to share experiences and to exchange ideas in order to facilitate students' participation in problem solving in the classroom. By importing the problem-solving strategy into such peer groups, teachers can participate in their own professional development, which would ultimately benefit current and future students.

It should be emphasized that the problem-solving strategy becomes effective through active intellectual participation on a regular basis – in the classroom as well as during individual problem solving. Application of the strategy should not be diminished to the writing of steps supplied by the teacher; as this would be a recreation of teacher-dominated classroom practice. It would be equally futile to restrict the application of the strategy as an attempted quick fix for test purposes, as this would bypass the conceptual development that takes place during application of the strategy while learning new content, as well as during individual study. If the need of intellectual engagement and regular practice is not understood clearly, the strategy would lose its value as a tool for learning to interpret concrete problem situations in terms of physics principles.

Teachers should be explicitly informed about the way in which the problem-solving strategy enhances problem solving through conceptual development while learning new content.

Classroom problem solving should be utilized as learning experiences for students. The teachers should facilitate learner participation on an intellectual level and challenge learners to explain their reasoning. Suitable problems that can provide both variety and repetition to create familiarity with ranges of concrete problem situations and relevant abstract physics concepts need to be selected.

Isolated problems would lead to isolated instances of conceptual understanding. Familiarity with types of problems can connect isolated instances of conceptual understanding to well-established conceptual networks, which can be accessed in future problems.

The implementation of the structured problem-solving strategy should start early in secondary school with simple physics problems like those involving density and pressure calculations. An early start could encourage conceptualizing as a problem-solving routine and prevent a formula-based approach from taking root. Interpretation of the more concrete physics concepts in grades 8 and 9 would make it easier to understand abstract concepts in later years. An early start would be of particular importance for complementary development of second language usage and conceptual understanding.

Perhaps the most difficult goal for teachers and students would be to adopt the routine of applying a problem-solving strategy, which could ultimately lead to a conceptual approach. A sure way to establish the routine would be to reward qualitative arguments along with mathematical solutions in tests and examinations. Unfortunately, the national final examinations do not make provision for rewarding qualitative arguments in solutions to problems. As a consequence, school examinations also focus on algebraic solutions to physics problems, thus participating in a vicious cycle. Should a teacher decide to step out of the algebraic routine by rewarding students' qualitative arguments, their students would reap the rewards of enhanced conceptual understanding and successful problem solving – ultimately earning better marks that may lead to scientific career options.

Finally, it is recommended that structured problem solving be implemented in South Africa's disadvantaged schools. It is a small intervention that can unlock human potential. Teachers and students would be empowered to participate in knowledge construction, making a contribution to meaningful development in disadvantaged South African schools.



## REFERENCES

- Alant, B. (2004). Researching problem solving in introductory physics: Towards a new understanding of familiarity. *African Journal of Research in Mathematics, Science and Technology Education*, 8, 29-40.
- Arnott, A., Kubeka, Z., Rice, M., & Hall, G. (1997). *Mathematics and science teachers: Demand, utilization, supply and training in South Africa*. Johannesburg: Edusource.
- Bashkar, R., & Simon, H.A. (1977). Problem solving in semantically rich domains: An example from engineering thermodynamics. *Cognitive Science*, 1, 193-215.
- Chekuri, N.R., & Markle, G.C. (2004). Physics instructional design to improve cognitive skills and scientific reasoning. Proceedings of the annual conference of the National Association for Research in Science Teaching and Learning, Vancouver.
- Chi, M.T.H., Feltovich, P.J., & Glaser, R. (1981). Categorization and representation of physics problems by experts and novices. *Cognitive Science*, 5, 121-152.
- Christie, P. (1999). OBE and unfolding policy trajectories: Lessons to be learned. In Jansen, J. & Christie, P. (Eds.), *Changing curriculum: Studies on outcomes-based education in South Africa* (pp. 279-292). Cape Town: Juta.
- Connolly, P. (1989). Writing and the ecology of learning. In P. Connolly & T. Vilardi (Eds.), *Writing to learn mathematics and Science*. New York: Teachers College Press.
- Department of Education. (1997). <http://www.policy.org.za/govdocs/misc/curr2005.html>
- Department of Education. (2003). Pretoria. <http://education.pwv.gov.za>
- Duit, R., Roth, W.M., Komorek, M., & Wilbers, J. (1998). Conceptual change cum discourse analysis to understand cognition in a unit on chaotic systems: towards an integrative perspective on learning in science. *International Journal of Science Education*, 20, 1059-1073.
- Eylon, B., & Reif, F. (1984). Effects of knowledge organization on task performance. *Cognition and Instruction*, 1, 5-44.
- Fergusson-Hessler, M.G.M., & de Jongh, T. (1987). On the quality of knowledge in the field of electricity and magnetism. *American Journal of Physics*, 55, 492-497.
- Finegold, M., & Mass, R. (1985). Differences in the process of solving physics problems between good physics problem solvers and poor physics problem solvers. *Research in Science and Technological Education*, 3, 59-67.

Fraser, D., Linder, C., & Pang, M.F. (2004). Learning through variation, part 1: a pedagogical tool. Proceedings of the 12<sup>th</sup> Annual Meeting of the Southern African Association for Research in Mathematics, Science and Technology Education. Cape Town.

Gall, M.D., Borg, W.R., & Gall, J.P. (1996). *Educational research: An introduction*, 6<sup>th</sup> edition, New York: Longman Publishers.

Government Gazette, (15 March 1995). White paper on education and training. 357 (16312). Cape Town, South Africa.

Grayson, D.F. (1996). A holistic approach to preparing disadvantaged students to succeed in tertiary science studies. Part 1. Design of the Science Foundation programme. *International Journal of Science Education*, 18, 998-1013.

Greeno, J.G. (1989). Situations, Mental Models, and Generative Knowledge. In D. Klahr, and K. Kotovsky (Eds.). *Complex Information Processing: The Impact of Herbert A. Simon*, (pp.285-318), Hillsdale, NJ: Lawrence Erlbaum Associates.

Halloun, I. (1996). Schematic modeling for meaningful learning of physics. *Journal of Research in Science Teaching*, 33, 1019-1041.

Halloun, I.A., & Hestenes, D. (1987). Modeling instruction in mechanics. *American Journal of Physics*, 55, 455-462.

Halloun, I.A., & Hestenes, D. (1985a). The initial knowledge state of first year college physics students. *American Journal of Physics*, 53, 1053-1055.

Halloun, I.A., & Hestenes, D. (1985b). Common sense concepts about motion. *American Journal of Physics*, 53, 1056-1065.

Hartshorne, K. (1992). *Crisis and challenge: Black education 1910-1990*. Cape Town, South Africa: Oxford University Press.

Heller, J.I., & Reif, F. (1984). Describing effective human problem solving processes: Problem description in physics. *Cognition and Instruction*, 1, 177-216.

Heller, P., & Heller, K. (1995). *The competent problems solver: A strategy for solving problems in physics*. Minneapolis, MN. McGraw-Hill.

Heller, P., Keith, R., & Anderson, S. (1992). Teaching problem solving through cooperative grouping. Part 1: Group versus individual problem solving. *American Journal of Physics*, 60, 627-636.

Hestenes, D. (1987). Toward a modeling theory of instruction. *American Journal of Physics*, 55, 440-454.

Hestenes, D., Wells, M., & Swackhamer, G. (1992). Force Concept Inventory. *The Physics Teacher*, 30, 141-158.

Hewitt, P.G. (1983). Millikan Lecture 1982: The missing essential – a conceptual understanding of physics. *American Journal of Physics* 51, 305-311.

Hobden, P.A. (1999). *The context of problem tasks in school physical science*. Doctoral dissertation, University of Natal, Durban.

Howie, S.J. (2001). *Mathematics and science performance in gr.8 in South- Africa, 1998/9*. Pretoria: HSRC.

Howie, S.J. (2003). Language and other background factors affecting secondary pupils' performance in mathematics in South Africa. *African Journal of Research in Science, Mathematics and Technology Education*, 7, 1-20.

Huffman, D. (1997). Effect of explicit problem solving instruction on high school students' problem-solving performance and conceptual understanding of physics. *Journal of Research in Science Teaching*, 34, 551-570.

Jansen, J.D. (1999). Why outcomes-based education will fail: an elaboration. In Jansen, J. & Christie, P. (Eds.), *Changing curriculum: Studies on outcomes-based education in South Africa* (pp. 145-155). Cape Town: Juta..

Johnson, S., Monk, M., & Hodges, M. (2000). Teacher development and change in South Africa: a critique of the appropriateness of transfer of northern/western practice. *Compare*, 30, 180-192.

Kahn, M. (1994). The role of science and mathematics non-governmental organization in future education and training dispensation: an environmental scan. In S. Levy (Ed.), *Projects that speak for themselves* (2nd. ed., pp. 37-42). Pietermaritzburg, South Africa: Shuter & Shooter.

Kahn, M. (2004). For whom the school bell tolls: Disparities in performance in senior certificate mathematics and physical science. *Perspectives in Education*, 22, 149-156.

Larkin, J.H., & Reif, F. (1979). Understanding and teaching problem solving in physics. *European journal of science education*, 1, 191-203.

Larkin, J.H., & Simon, H.A. (1987). Why a diagram is (sometimes) worth ten thousand words. *Cognitive Science*, 11, 65-99.

Larkin, J.H. (1983). The role of problem representation in physics. In D. Gentner & A.L. Stevens (Eds.), *Mental Models* (pp.75-98). Hillsdale, NJ: Lawrence Erlbaum.

Larkin, J.H. (1979). Processing information for effective problems solving. *Engineering Education*, 285-288.

- Larkin, J.H., McDermott, L., Simon, D.P., & Simon, H.A. (1980). Expert and novice performance in solving physics problems. *Science*, 208, 1335-1342.
- Lawson, R.A., & Mc Dermott, L. (1987). Student understanding of the work-energy and impulse-momentum theorems. *American Journal of Physics*, 55, 811-817.
- Leonard, W.J., Dufresne, R.J., & Mestre, J.P. (1996). Using qualitative problem-solving strategies to highlight the role of conceptual knowledge in solving problems. *American Journal of Physics*, 64, 1495-1503.
- Macdonald, M.A., & Rogan, J.M. (1988). Innovations in South African Science education (part 1): Science teaching observed. *Science Education*, 72, 225-236.
- Macdonald, M.A., & Rogan, J.M. (1990). Innovations in South African Science education (part 2): Factors influencing instructional change. *Science Education*, 74, 119-132.
- Maloney, D.P. (1994). Research on problem solving: Physics. In D.L. Gabel (Ed.), *Handbook of Research in Science Teaching and Learning* (pp. 327-354). New York: Macmillan.
- McDermott, L.C., & Redish, E.F. (1999). Resource letter on physics education research. *American Journal of Physics*, 67, 755-767.
- McDermott, L.C., & Shaffer, P.S. (1992): Research as a guide for curriculum development: An example from introductory electricity. Part I: Investigation of student understanding. *American Journal of Physics*, 60, 994-1003.
- McDermott, L.C. (1991), Millikan Lecture 1990: What we teach and what is learned – closing the gap, *American Journal of Physics*, 59, 301-315.
- McMillan C., & Swadener, M. (1991). Novice use of qualitative versus quantitative problem solving in electrostatics. *Journal of Research in Science Teaching*, 28, 661-670.
- Monk, M., & Johnson, S. (1995). How do you know that: an epistemological challenge? *Science Education International*, 6, 21-24.
- Padgett, W.T. (1991). The long list and the art of solving physics problems. *The Physics Teacher*, 29, 238-239.
- Parkinson, J. (2000). Widening access to tertiary science study: the ‘augmented’ model. *South African Journal of Science*, 96, 213-216.
- Pinto, D. (2001). Directory of science, engineering and technology foundation programmes. *Proceedings of the ‘Indaba’ of S, E and T Foundation Programmes*. Johannesburg: University of the Witwatersrand.
- Polya, G. (1948). *How to solve it*. Princeton, NJ: Princeton University Press.

Posner, G.J., Strike, K.A., Hewson, P.W., & Gertzog, W.A. (1982). Accomodation of a scientific conception: Toward a theory of conceptual change. *Science Education*, 66, 211-227.

Pride, T., Vokos, S., & McDermott, L. (1998). The challenge of matching learning assessments to teaching goals: An example from the work-energy and impulse-momentum theorems. *American Journal of Physics*, 66, 147-157.

Prophet, R. B. (1990). Rhetoric and reality in science curriculum development in Botswana. *International Journal of Science Education*, 12, 13-23.

Redish, E.F. (1994). Implications of cognitive studies for teaching physics. *American Journal of Physics*, 62, 796-803.

Reichling, J.P. (2003). *Applying modeling methods to a chemistry in the community (ChemCom) course*. Masters dissertation, University of Wisconsin-Madison. Madison WI.

Reif, F., & Heller, J.I. (1982). Knowledge structures and problem solving in physics. *Educational Psychologist*, 17, 102-127.

Reif, F. (1995). Millikan Lecture 1994: Understanding and teaching important scientific thought processes. *American Journal of Physics*, 63, 16-32.

Reif, F., Larkin, J. H., & Brackett, G.C. (1976). Teaching general learning and problem solving skills. *American Journal of Physics*, 44, 212-217.

Rogan, J.M., & Gray, B.V. (1999). Science Education as South Africa's Trojan Horse. *Journal of Research in Science Teaching*, 36, 373-385.

Rogan, J.M., & Grayson, D.J. (2003). Towards a theory of curriculum implementation with particular reference to science education in developing countries. *International Journal of Science Education*, 25, 1771-1204.

Rogan, J.M., & Macdonald, M.A. (1985). The in-service teacher education component of an innovation: a case study in an African setting. *Journal of Curriculum Studies*, 17, 63-85.

Roth, W.-M. (1996). *The co-evolution of situated language and physics knowing*. *Journal of Science Education and Technology*, 3, 171-191.

Rutherford, M. (1997). Opening access to quality education. *South African Journal of Science*, 93, 61-66.

Schoenfeld, A.H. (1985). *Mathematical problem solving*. San Diego, CA: Academic.

Shaffer, P.S., & McDermott, L.C. (1992). Research as a guide for curriculum development: An example from introductory electricity. Part II: Design of instructional strategies. *American Journal of Physics*, 60, 1003-1013.

Simon, D.P., & Simon, H.A. (1978). Individual differences in solving physics problems. In R.S. Siegler (Ed.), *Children's thinking: What develops?* (pp. 325-348). Hillsdale, NJ: Lawrence Erlbaum.

Stanton, M. (1987). An evaluation of a first-year half-course in physics for bridging students at the University of the Witwatersrand. *South African Journal of Higher Education*, 1, 105-111.

Stoffels, N.T. (2004). *Sir, on what page is the answer? Exploring teacher decision-making in the context of complex curriculum change*. Doctoral dissertation, University of Pretoria, Pretoria.

Van Heuvelen, A. (1991 a). Learning to think like a physicist: a review of research based instructional strategies. *American Journal of Physics*, 59, 891-897.

Van Heuvelen, A. (1991 b). Overview, case study physics. *American Journal of Physics*, 59, 898-907.

Wright, D.S., & Williams, C.D. (1986). A WISE strategy for introductory physics. *The Physics Teacher*, 24, 211-216.

## APPENDIX 1

### PRE-TEST

1. Airport Y is located 600 km directly south of airport X. An aeroplane has to travel from X to Y while a wind blows at 40 km/h from the west. The aeroplane travels at an airspeed of 200 km/h.
  - a. Draw a labeled vector diagram (not to scale) to show the direction in which the aeroplane should be pointed. Indicated the velocity of the plane relative to the ground by  $V_g$ . (6)
  - b. Use the diagram in (a) to calculate the direction in which the plane should be pointed during the trip. (3)
  - c. Calculate the time taken to reach Y. (6)
  
1. Lesego is an athlete running the 100 meter. He accelerates uniformly at  $5 \text{ m}\cdot\text{s}^{-2}$  for the first 10 meter. Then he runs at a constant velocity for the remainder of the race.
  - a. Calculate the time he takes to run the first 10 m. (5)
  - b. Calculate his speed at the end of the first 10 m. (5)
  - c. Calculate his time for the 100 m. (5)

TOTAL 30

## APPENDIX 2

### FEBRUARY TEST

1. A helicopter accelerates vertically upwards at  $2 \text{ m}\cdot\text{s}^{-2}$ . Two crates are hanging from the helicopter. Two different cables are used; one cable connects the crates while the other attaches the 200 kg crate to the helicopter as shown in the diagram.

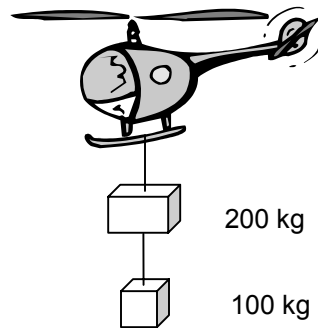

- a. Draw two labeled force diagrams, showing the forces acting on each crate. (5)
- b. Write down the equation of motion for each crate and calculate tension in each cable. (7)
- c. If the two crates were swapped such that the 100 kg is above the 200 kg, what would the tension be in
- (i) the upper cable and
- (ii) the lower cable? (2)
2. Thabang leans out of a window of a building and throws a ball vertically upwards. The ball reaches a maximum height of 45 m above the window. The window is 35 m above ground level.
- a. Calculate the initial velocity of the ball. (5)
- b. Calculate the time the ball takes to reach the ground. (6)
- c. Calculate the velocity of the ball when it hits the ground. (5)

TOTAL 30



### APPENDIX 3

### MARCH TEST

1 A lift with mass 2000 kg accelerates upwards through a height of 5 meter. The lift is driven by a motor supplying a constant vertical force of 30 000 N.

- a Calculate the increase in the potential energy of the lift. (3)
- b Calculate the work done by the motor. (3)
- c Calculate the increase in the kinetic energy of the lift. (2)

2 A 60 g ball hits a wall with a horizontal velocity of  $30 \text{ m}\cdot\text{s}^{-1}$  South. The ball bounces back at  $30 \text{ m}\cdot\text{s}^{-1}$ .

- a. Calculate the force exerted by the wall on the ball if the impact lasts 0,01 seconds. (6)
- b Is the momentum of the ball conserved during the collision? (1)

3 A car with mass 200 kg starts moving at  $9 \text{ m}\cdot\text{s}^{-1}$  at A shown in the diagram. It moves without friction to B and collides with a stationary 400 kg car when it reaches B. The cars move together after the collision.

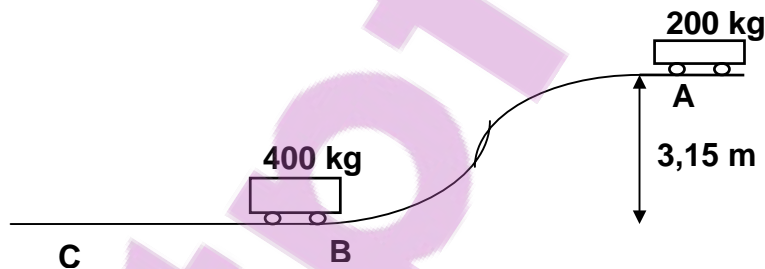

- a Calculate the speed of the cars immediately after the collision. (9)
- b The cars move together on a straight rough horizontal surface from B to C, coming to rest at C. Calculate the frictional force acting on the cars if the distance between C and B is 6 m. (6)

TOTAL 30

## APPENDIX 4

### MAY TEST

- 1 Two charged spheres are placed 300 mm apart as shown in the diagram.

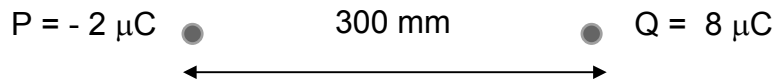

- a Calculate the electrostatic force between the two charges. (5)
- b Calculate the electric field at the position of P. (5)
- 2 Two large, oppositely charged parallel plates are placed 50 mm apart in vacuum. The electric field strength between the plates is  $160\,000 \text{ V}\cdot\text{m}^{-1}$ .
- a Calculate the potential difference between the plates. (4)
- b A proton is released from rest at the positive plate. Calculate the kinetic energy of the proton when it reaches the negative plate. (4)
- c A positive ion is then released at the positive plate. It has the same charge but larger mass than the proton in (b). Is the kinetic energy of the ion larger, smaller or equal to that of the proton when it reaches the negative plate? Explain. (2)
- 3 While trying to do the Millikan experiment, a student observes a charged oil drop **accelerating** upwards at  $1 \text{ m}\cdot\text{s}^{-2}$  towards the negative plate. The mass of the oil drop is  $4 \times 10^{-6} \text{ kg}$ , the potential difference between the plates is 6000 V and the plates are separated by 200 mm.
- a Calculate the charge on the oil drop. (7)
- b Does the acceleration of the oil drop increase, decrease or remain unchanged as it moves closer to the top plate? Explain. (2)
- c Peter calculated the charge on the oil drop and obtained an answer of  $3,2 \times 10^{-20} \text{ C}$ . Why can you be sure that Peter's answer is wrong?(1)

TOTAL 30

**APPENDIX 5:  
JUNE EXAMINATION**

**Physics Grade 12 Higher Grade**

Time: 2 hours

Total: 150

**QUESTION 1**

1.1 What is the relationship between the vectors **X**, **Y** and **Z** in the diagram?

- A  $\mathbf{X} + \mathbf{Y} + \mathbf{Z} = \mathbf{0}$
- B  $\mathbf{X} = \mathbf{Y} + \mathbf{Z}$
- C  $\mathbf{Y} = \mathbf{X} + \mathbf{Z}$
- D  $\mathbf{Z} = \mathbf{X} + \mathbf{Y}$

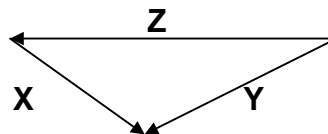

1.2 Ntabiseng throws a ball vertically upwards and catches it as it returns. At the turning point, the ball's acceleration:

- A is zero
- B changes direction;
- C is  $10 \text{ ms}^{-2}$  downwards;
- D is  $10 \text{ ms}^{-2}$  upwards.

1.3 A ship travels horizontally to the right at a constant velocity. Which diagram is the best representation of the forces acting on the ship?

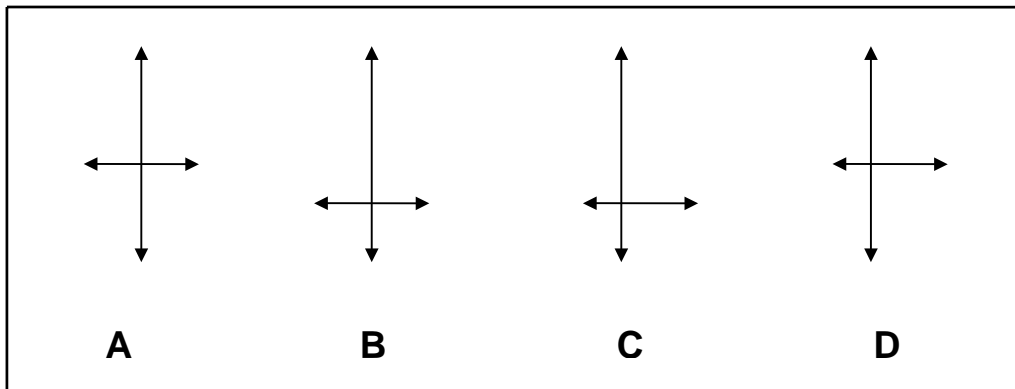

- 1.4 James pulls a block at a constant velocity over a rough horizontal surface. He applies a 12 N force at an angle of  $30^\circ$  above the horizontal.

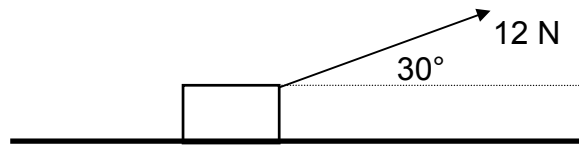

The frictional force is:

- |   |      |   |        |
|---|------|---|--------|
| A | zero | B | 12 N   |
| C | 6N   | D | 10,4 N |
- 1.5 Thabang and Edwin investigate the relationship between mass and acceleration during a practical session. They measure the acceleration for different masses by stacking trolleys. They apply the same force in each case. The acceleration was  $1,2 \text{ m}\cdot\text{s}^{-2}$  for one trolley only. What is the acceleration for a stack of three trolleys?
- |   |                                   |   |                                    |
|---|-----------------------------------|---|------------------------------------|
| A | $3,6 \text{ m}\cdot\text{s}^{-2}$ | B | $0,6 \text{ m}\cdot\text{s}^{-2}$  |
| C | $0,4 \text{ m}\cdot\text{s}^{-2}$ | D | $0,33 \text{ m}\cdot\text{s}^{-2}$ |
- 1.6 An object with mass  $m$  hangs at rest from a string. The string exerts a force  $T$  on the object. Which statement is correct?
- i  $F_{\text{resultant}} = mg$
  - ii  $T = mg$
  - iii  $F_{\text{resultant}} = 0$
  - iv  $T = ma$
- |   |            |   |          |
|---|------------|---|----------|
| A | ii and iii | B | i and iv |
| C | only i     | D | only iii |
- 1.7 A satellite orbits the earth at a height 2 times the radius of the earth. What is the weight of a 90 N instrument in the satellite?
- |   |        |   |      |
|---|--------|---|------|
| A | 45 N   | B | 30 N |
| C | 22,5 N | D | 10 N |
- 1.8 A stone with mass  $m$  falls from a cliff and hits a pool of mud with a speed  $v$ . It sinks to a depth  $d$  into the mud before coming to rest. How much work does the stone do on the mud?
- |   |                          |   |                          |
|---|--------------------------|---|--------------------------|
| A | $\frac{1}{2} mv^2$       | B | $mgd$                    |
| C | $\frac{1}{2} mv^2 + mgd$ | D | $\frac{1}{2} mv^2 - mgd$ |

- 1.9 The electrostatic force on the  $2 \mu\text{C}$  charge at Y in the diagram below is 10 N.

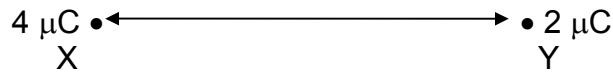

What is the electrostatic force on the charge at X?

- A 10 N to the right                      B 10 N to the left  
 C 5 N to the right                        D 5 N to the left
- 1.10 A negatively charged particle is placed between two oppositely charged parallel plates shown in the diagram. At which position will it experience the largest force?

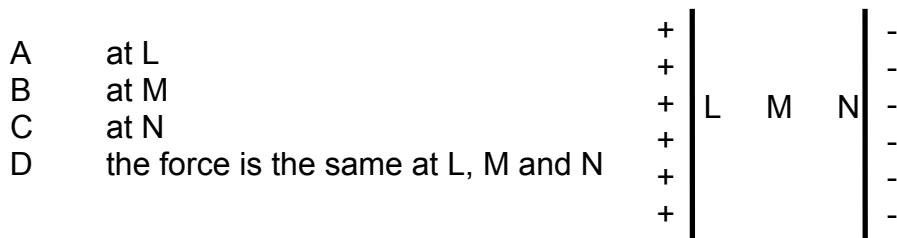

- 1.11 A student calculates charges on oil drops in a Millikan experiment and obtains the answers A to D below. In which one of the calculations did he make a mistake?

- A  $3,2 \times 10^{-19} \text{ C}$                       B  $4,8 \times 10^{-18} \text{ C}$   
 C  $-6,4 \times 10^{-19} \text{ C}$                     D  $1,6 \times 10^{-20} \text{ C}$

- 1.12 P is a point halfway between charges L and M as shown in the diagram. The electric field strength of charge L has a magnitude E at point P.

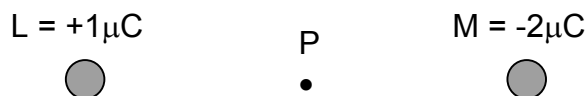

What is the resultant field strength at P?

- A E, to the right                          B E, to the left  
 C 3 E, to the left                        D 3 E, to the right

[12 x 4 = 48]

## QUESTION 2

- 2.1 A minibus travels at a constant speed of  $32 \text{ m.s}^{-1}$  on a straight road. The driver sees a stationary truck 130 m down the road. The reaction time of the driver is 0,2 s. The driver then applies the brakes, decreasing his speed uniformly at  $4 \text{ m.s}^{-2}$ . Does the minibus come to rest before reaching the truck? Do a suitable calculation to support your answer. (10)
- 2.2 A helicopter pilot leans out of the helicopter door while ascending (going up) vertically at an unknown constant speed. At a height of 7 m above the ground, he accidentally drops his pipe. The pipe starts from rest relative to the helicopter and reaches the ground within 1,4 seconds. Ignore friction and calculate:
- the speed of the helicopter; (5)
  - the maximum height the pipe reach above the ground. (6)
  - Draw displacement-time and a velocity-time graphs for the motion of the pipe. Numerical values are **not required** on the graphs (4)
- [25]

## QUESTION 3

- 3.1 A 80 kg lady stands on a bathroom scale in a lift.
- Determine the reading on the scale when the lift accelerates downward at  $1 \text{ m.s}^{-2}$  (6)
  - Give the value of the resultant force on the lady. (2)
- 8 Two blocks with masses 6 kg and 5 kg are connected by a light string and pulled over a rough surface by a 40 N force applied to the 6 kg block. The frictional forces are 4 N on the 6 kg block and 3 N on the 5 kg block.

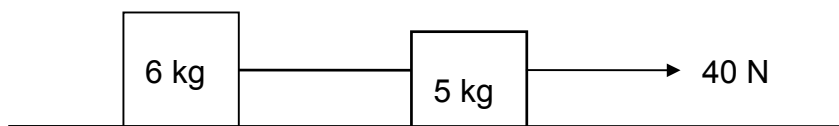

- Write down the equation of motion for each block. (6)
  - Use the equations in (a) to calculate the acceleration of the blocks and the tension in the string. (4)
- [18]

#### QUESTION 4

4.1 During a game of marbles, a 4 gram marble moves at  $3 \text{ m}\cdot\text{s}^{-1}$  North and collides with an 8 gram marble moving at  $1 \text{ m}\cdot\text{s}^{-1}$  South. The 4 g marble moves at  $1 \text{ m}\cdot\text{s}^{-1}$  South after the collision.

- a Calculate the velocity of the 8 gram marble after the collision. (6)
- b Calculate the average force on the 4 g marble during the collision if the marbles are in contact for 0,01seconds. (6)
- c What is the force on the 8 g marble during the collision? (2)

4.2 A car with mass 200 kg starts at A and rolls down a track as shown in the diagram. It reaches B with a speed of  $12 \text{ m}\cdot\text{s}^{-1}$ .

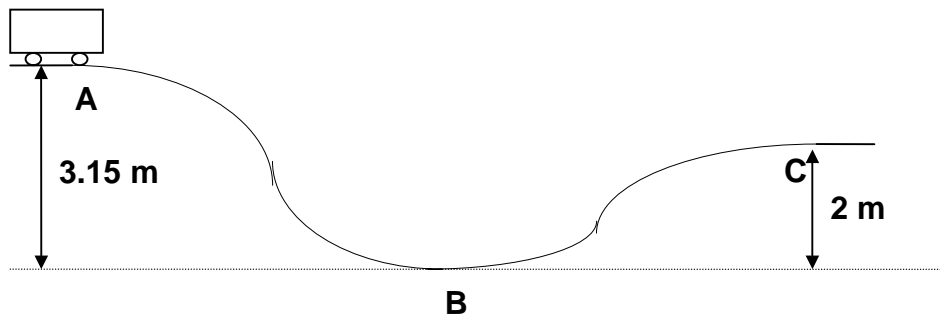

- a Calculate the speed with which the car has started at A. Assume there is **no friction** between A and B. (5)
  - b The track between B and C is **rough**. The car does work of 2 300 J against friction while moving from B to C. Calculate the speed of the car when it reaches C. (5)
- [24]

#### QUESTION 5

5.1 Two parallel metal plates are separated by 3 cm. The electric field strength between the plates is  $90\,000 \text{ V/m}$ . A particle with a charge of  $2 \mu\text{C}$  is released from rest at the positive plate.

- a Calculate the potential difference between the two plates. (4)
- b Calculate the kinetic energy of the charge when it reaches the negative plate. (4)
- c How does the potential energy of the particle change while it moves to the negative plate? (2)

- 5.2 A charged polystyrene ball A lies at the bottom of a glass cylinder. An identically charged polystyrene ball B is dropped into the cylinder. B is repelled by A and comes to rest above A such that the distance between the centers of the balls is 9 cm. The mass of each ball is 10 g. Calculate the charge on each ball. (7)

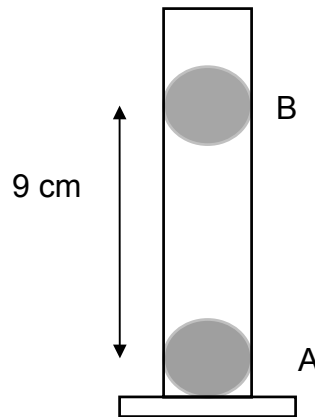

[17]

### QUESTION 6

The EMF of the battery in the diagram below is 14 volt. When the switch S is closed, the reading on voltmeter  $V_1$  is 12 volt. Calculate the following when the switch is closed:

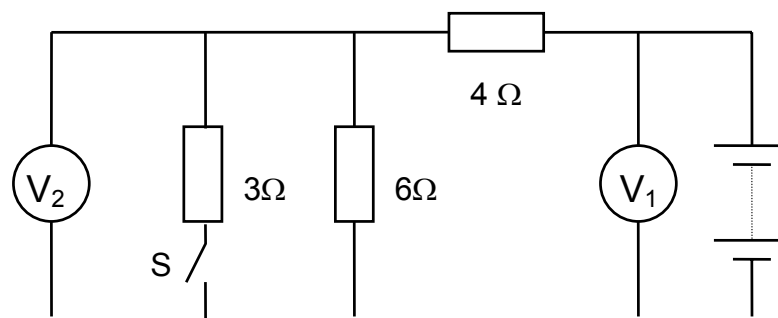

- a the current in the  $4 \Omega$  resistor; (6)
- b the reading on voltmeter  $V_2$ ; (3)
- c the current in the  $3 \Omega$  resistor; (3)
- d the internal resistance of the battery. (3)
- e How would the following change if the switch S were opened? (3)
  - i) the total resistance;
  - ii) the current in the battery;
  - iii) the reading on the voltmeter  $V_1$ . (18)

TOTAL 150





## APPENDIX 7

### VIDEO GROUP'S QUESTIONNAIRE

1. Some students did not use the strategy when answering test and exam question. What do you think is the reason?
2. Do you think the strategy was helpful, even if students did not write all the steps in exams?
3. You used to solve Physics problems in your own way before you learnt the strategy. Which step(s) of the strategy were not part of your own approach? Explain.
4. Do you think that students who learnt the strategy have an advantage over students who did not learn the strategy? Explain.
5. Did the strategy change your way of thinking and doing when you solve problems? Explain.
6. Did the strategy in any way improve your understanding of Physics?
7. How often did you use the strategy when doing homework / classwork?
8. How often did your teacher use the strategy when doing problems on the blackboard?
9. What does your teacher normally say/do before writing the appropriate formula on the blackboard?

## APPENDIX 8

### TEACHERS' QUESTIONNAIRE

1. Did your grade 12 students participate in any science project **other** than the project on “Structured Problem Solving” during the year 2001? Please give details.

---

---

---

---

2. You attended a few workshops on the “ Structured Problem Solving Strategy” . Did you attend any **other** teacher workshops or in-service training courses during the year 2001? Please give details.

---

---

---

---

3. Few students wrote down the 7 steps of the “Structured Problem Solving Strategy” when answering test and examination questions. Does this mean that the strategy **does not work**? Please give your opinion.

---

---

---

---

4. You used to solve problems in your own way before learning the “Structured Problem Solving Strategy”. Some aspects of the strategy may be similar to your own approach. Which aspects of the strategy **differ** from your own approach?

---

---

---

---

5. Do you think that your future teaching methods will reflect some aspects of the “Structured Problem Solving Strategy”? Please state those aspects that you **intend to apply in future**.

---

---

---

---

6. Do you think that teaching the strategy to your learners improved your **own** ability to solve physics problems? Please discuss.

---

---

---

---

7. Do you think that teaching the strategy to your learners made you a more effective teacher in Chemistry? Please discuss.

---

---

---

---

8. Do you think that using the strategy **changed** your students' ways of thinking about physics? Please discuss.

---

---

---

---

9. Do you think that using the strategy changed your students' ways of thinking about **chemistry**? Please discuss.

---

---

---

---

10. Do you think that students who learnt the "Structured Problem Solving Strategy" have an advantage over students who did not learn it?

---

---

---

---

11. What **recommendations** would you make to improve the "Structured Problem Solving Strategy"?

---

---

---

---

12. If there are any other thoughts that you would like to share, please use the space below.

---

---

13. Please indicate to which extent you agree with the statements below. Indicate each choice by ticking the appropriate number on a 5-point scale.

1=strongly disagree

2=disagree

3=unsure

4=agree

5=strongly agree

**“Structured Problem Solving” improved my students’:**

marks	1	2	3	4	5
self-confidence	1	2	3	4	5
understanding of physics concepts	1	2	3	4	5
problem solving skills	1	2	3	4	5
enjoyment of physics	1	2	3	4	5
ability to formulate thoughts mathematically	1	2	3	4	5
ability to formulate thoughts in words	1	2	3	4	5

## APPENDIX 9

### EXAMPLES OF CONCEPTUAL AND ALGEBRAIC SOLUTIONS PRESENTED IN THE JUNE EXAM

#### Question 4.1 (a)

During a game of marbles, a 4 gram marble moves at  $3 \text{ m.s}^{-1}$  North and collides with an 8 gram marble moving at  $1 \text{ m.s}^{-1}$  South. The 4 g marble moves at  $1 \text{ m.s}^{-1}$  South after the collision.

Calculate the velocity of the 8 gram marble after the collision. (6)

#### 1. Conceptual approach by a treatment group student using the strategy.

Question 4

4.1. Diagram + Information

Before

$m_1 = 0,004 \text{ kg} = m_1$   
 $u_1 = 3 \text{ m.s}^{-1}$

$m_2 = 0,008 \text{ kg} = m_2$   
 $u_2 = -1 \text{ m.s}^{-1}$

---

After

$m_1 = 0,004 \text{ kg}$   
 $v_1 = -1 \text{ m.s}^{-2}$

$m_2 = 0,008 \text{ kg}$   
 $v_2 = ?$

a) Unknown:  $v_2 = ?$  (after collision)

Analysis: Law of conservation of momentum

Relation: physics = paper

Substitution + Solution:  $m_1 u_1 + m_2 u_2 = m_1 v_1 + m_2 v_2$

$$(0,004)(3) + (0,008)(-1) = (0,004)(-1) + (0,008)(v_2)$$

$$0,012 - 0,008 = -0,004 + 0,008 v_2$$

$$0,004 + 0,004 = 0,008 v_2$$

$$0,008 = 0,008 v_2$$

$$\underline{v_2 = 1 \text{ m.s}^{-1}}$$

Interpretation: The velocity of the 8 gram ball after collision is  $1 \text{ m.s}^{-1}$  North.

2. Conceptual approach by a treatment group student who did not show steps of the problem solving strategy.

Question 4

North as +ve direction

$m_1 = 4g = 0,004kg$   
 $m_2 = 8g = 0,008kg$

Total momentum after = Total momentum before

$$m_1 v_1 + m_2 v_2 = m_1 v_1 + m_2 v_2$$

$$(0,004kg \times 3ms^{-1}) + (0,008kg \times v_2) = (0,004kg \times 1ms^{-1}) + (0,008kg \times -1ms^{-1})$$

$$0,012kgms^{-1} + 0,008kg \times v_2 = 0,004kgms^{-1} - 0,008kgms^{-1}$$

$$0,008kg \times v_2 = 0,004kgms^{-1} - 0,012kgms^{-1}$$

$$0,008kg \times v_2 = -0,008kgms^{-1}$$

$$v_2 = -1ms^{-1} \text{ North}$$

6

3. Conceptual approach by a control group student.

Question 4

4.1 (a)  $P(\text{before})_{\text{marbles}} = P(\text{after})_{\text{marbles}}$

For A:  $m = 0,004kg$   
 Assume  $u = -3ms$  North  
 For B:  $m = 0,008kg$   
 and  $u = +1$  South

directions

$$(mu)_A + (mu)_B = (m_1 + m_2)v$$

$$(0,004 \times -3) + (0,008 \times 1) = (0,004 \times v) + 0,008v_B$$

$$-0,012 + 0,008 = 0,004v + 0,008v_B$$

$$-0,004 = 0,004 + 0,008v_B$$

$$-0,004 - 0,004 = 0,008v_B$$

$$-0,008 = 0,008v_B$$

$$v_B = -1ms^{-1}$$

6

∴ The velocity of 8g marble will have  $v = 1ms$  in the direction of North after collision.



4. Algebraic approach by a control group student.

Question 4

✓

$$4.1 \ m_m u_m + m_c u_c = m_m v_m + m_c + u \ m_c u_c$$

$$(0,004 \times 3) + (0,008 \times (-1)) = (0,004 \times (-1)) + (0,008 \times v_c)$$

$$0,012 + (-0,008) = -0,004 + 0,008 v_c$$

$$0,012 - 0,008 = -0,004 + 0,008 v_c$$

$$0,004 + 0,004 = 0,008 v_c$$

$$\frac{0,008}{0,008} = \frac{0,008 v_c}{0,008}$$

$$v_c = 1 \quad \checkmark$$

$$\underline{v = 1 \text{ ms}^{-1}}$$

5

5. Algebraic approach with incorrect substitution by a control group student.

Q4

✓

$$4.1(a) \ m_1 u_1 + m_2 u_2 = m_1 v_1 + m_2 v_2$$

$$4 \cdot 3 + 8 \cdot 1 = 4 \cdot 1 + 8 \cdot v_2$$

$$12 + 8 = 4 + 8 \cdot v_2$$

$$20 - 4 = 8 \cdot v_2$$

$$\frac{16}{8} = \frac{8 \cdot v_2}{8}$$

$$\therefore v_2 = 2 \quad \times$$

2